

1

2

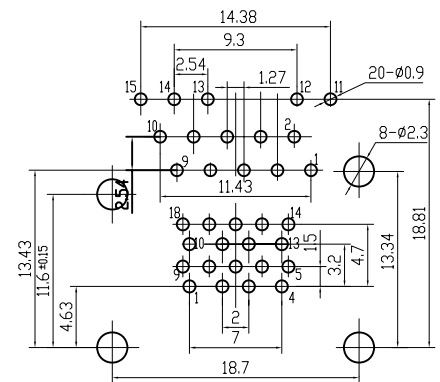
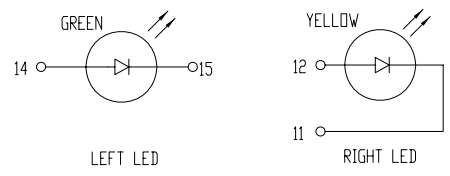
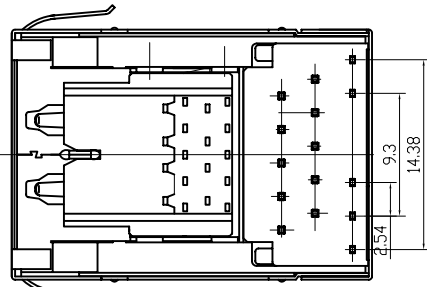

PCB BOARD LAYOUT

LED Specification

Standard LED Color	LED Wavelength	Forward (V MAX)	Typical (V TYP)	Luminous Intensity
Green	560-580 nm	2.5V	2.1-2.2V	9-25 MCD
Yellow	580-610 nm	2.5V	2.1-2.2V	9-30 MCD
Orange	580-610 nm	2.5V	2.1-2.2V	50-100 MCD

- LED intensity/wavelength measured with Photo Research PR-650 Colormeter
- With a forward current of 20 mA, Absolute Maximum Ratings (Ta=25°C)

Specification:
 1: TOLERANCES UNLESS OTHERWISE SPECIFIED :
 0~10±0.2, 10~20±0.25, 20~40±0.3,

2: JACK CAVITY CONFORMS TO FCC RULES AND REGULATIONS, PART 68 SUBPART F.

A

A

B

B

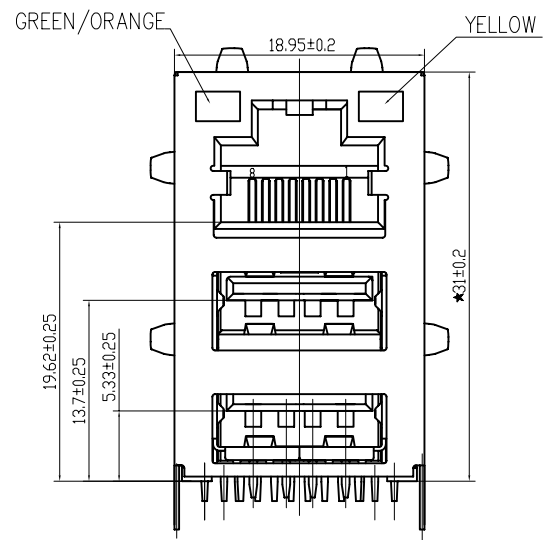
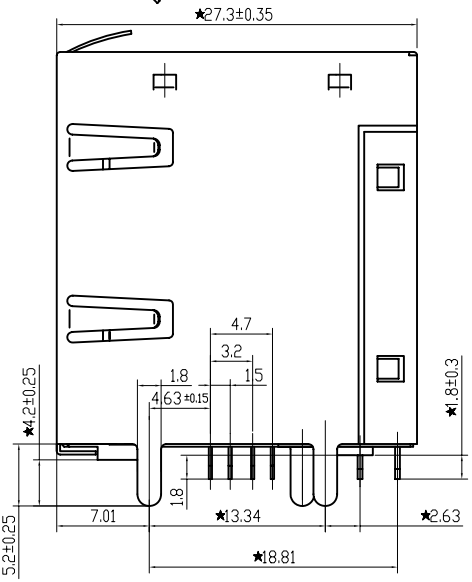

B-TOP® 东莞市博腾电子科技有限公司
 Dongguan BroadTop Electronic Technology Co., Ltd.

Designed	MATERIAL		DESCRIPTION		REV.
Checked	SCALE	UNIT	MODEL NO.	V1.0	
Approved	1:8:1	mm			

TEL: 0769-38926198
 FAX: 0769-38926199
 Website: www.BtopTech.cn
 www.BtopTech.com

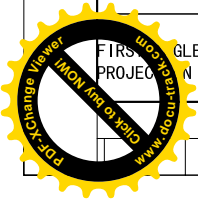

1

2

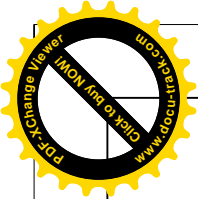

SHEMATIC RV1

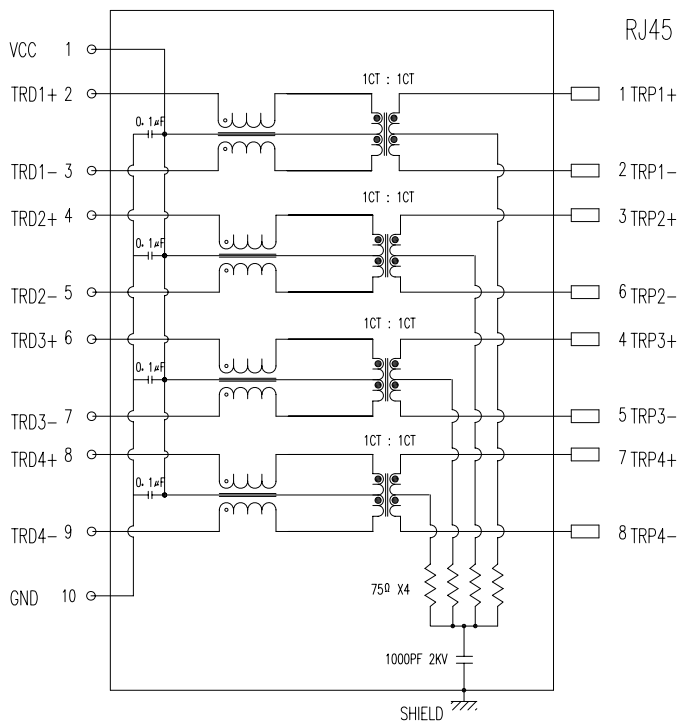

DESCRIPTION

ELECTRICAL: RJ45 With internal Magnetics Connector
 Designe to support such applications as:Ethernet Equipment Complex,Switches,Routers,Firewalls,Servers and Hub
 Internal magnetics are 100% electrically tested for functionality per IEEE802.3 requirement
 IR Reflow Peak Temperature: 250℃
 High performance for maximum EMI suppression
 350uH minnum OCL with 8mA bias current

MECHANICAL: JACK CAVITY CONFORMS TO FCC RULES AND REGULATIONS,PART 68 SUBPART F.
 INSERTION FORCE: 8 CONTACTS--900g,10 CONTACTS--1050g
 RETENTION STRENGTH: 7.7Kgs BETWEEN JACK AND PLUG
 DURABILITY: 750 MATING CYCLES Mini

MATERIAL: HOUSING: 1) GLASS FILLED PA66 (UL 94V-0)
 2) GLASS FILLED PA46/PA6T/PA9T/LCP<265℃> (UL 94V-0)
 3) GLASS FILLED PBT/PA/ABS/PC (UL 94V-0)

SPRING WIRE: 0.25-0.35mm THICKNESS PHOSPHOR BRONZE ALLOY SELECTIVE GOLD PLATING OVER NICKEL<50-80µ" >
 OVER TIN<60-120µ" >
 GOLD PLATING: 3µ", 6µ", 15µ", 30µ", 50µ"
 SHIELDING: 0.2-0.24mm THICKNESS COPPER ALLOY WITH NICKEL<50-100µ" > PLATED
 Storage: -40℃~85℃ Relative Humidity<70%
 Operating: -40℃~85℃



ELECTRICAL SPECIFICATIONS AT 25 °C

Insertion Loss dB max	Return Loss dB min		Crosstalk(db TYP)	Common Mode Rejection (dB TYP)	Hipot(vrms)
1-125MHz	1-30MHz	30- 80MHz	1- 100MHz	1-100MHz	
-1.2	-18	-18+20log(f/30MHz)	-30	-30	1500/0.5mA OR 2250DC/0.1mA

"B" with the company code

Series of products: 60:Double deck RJ45 connector + transformer series(In sidelong footprint); 59:Double deck RJ45 connector + transformer series(In vertical footprint);50: Single RJ45 + transformer series;52/53/55/56 LED/56/57/59: Ordinary RJ45 series;DX: that strip line series; 40: Conversion said Connectivity 80: Series that UK; 91: Automotive connector public Block;92: Automotive connector mother Block; 93: HDMI the head;94: HDMI mother Block; 95: SMT series; 96: RBIS for switches

Family code (sequence id):1-99

Type of product code: G: Gigabit RJ45 transformer; F: 1000base RJ45 transformer;
 Y:for no transformer RJ45 products; W: Series for board-to-board code

Number of magnetic ring

The No. of circuit

B N (Z) G X - M - A B C D - E H I

Product definition LOGO: 1 - Press "B-TOP";2- No "B-TOP"; 3- Other companies LOGO

Product definition plastic materials: 1-PA66,2-PA46, 3-PA, 4-PA6, 5-PBT, 6-ABS, 7-PA9T,8-PC,9-LCP
 Pin definition of the product:F-Pin after; B-Pin back; C- No definition of the product

Electroplating product definition: gold-plated terminals(degrees after nickel plated) 1-F µ" ; 2-3 µ" ;3-6 µ" ; 4-15 µ" ; 5-30 µ" ; 6-50 µ" ;7-(Ni-50 µ" ,Sn-80-120 µ");

Product shielding definition: 0 - no shielding shell; 1 - without shielding shell shrapnet; 2 - shelding a shell shrapnet; 3 - a half-sheld shell;

Products luminous definition: 0 - No LED; 1 -Left Yellow Right Green; 2 - Left Green Right Yellow; 3 - Double Green; 4 - Double Yellow; 5 - LED straight for the pin; 6 - A special definition;7 - Single linear LEDs

Products out port: 1-2X1 2-2X2 4-2X4 5-2X5 6-2X6 8-2x8 A-1X1 8-1X2 C-1X4 D-1X5 " E-1X6 1-1X8 U-(USB+RJ45) P-TAB UP1X1 1-H-TAB UP1X2 K-TAB UP1X4"

A

A

B

B

B-TOP® 东莞博腾电子科技有限公司
 Dongguan BroadTop Electronic Technology Co., Ltd.

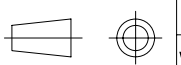

TEL: 0769-38926198
 FAX: 0769-38926199
 Website: www.BtopTech.cn
 www.BtopTech.com

Designed
 Checked
 Approved

MATERIAL
 SCALE 1.8:1 UNIT mm MODEL NO.

DESCRIPTION BT G8-165A -40℃~85℃
 REV. 1.0

