

1

2

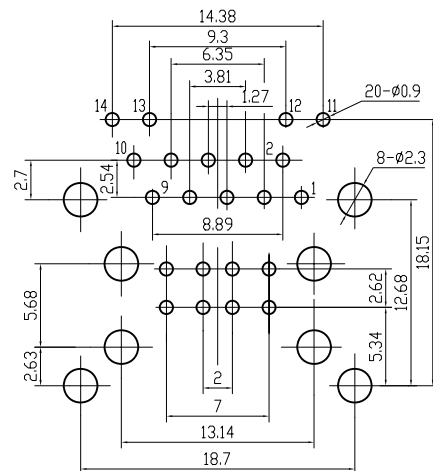

PCB BOARD LAYOUT

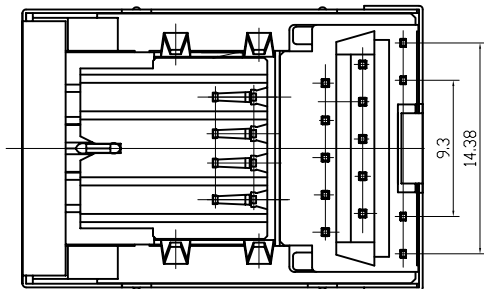
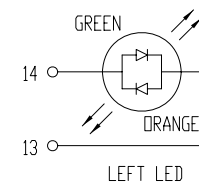

LEFT LED

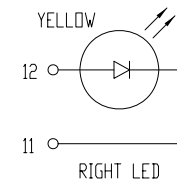

RIGHT LED

LED Specification

Standard LED Color	LED Wavelength	Forward (V MAX)	Typical (V TYP)	Luminous Intensity
Green	560-580 nm	2.5V	2.1-2.2V	9-25 MCD
Yellow	580-610 nm	2.5V	2.1-2.2V	9-30 MCD
Orange	580-610 nm	2.5V	2.1-2.2V	50-100 MCD

1. LED intensity/wavelength measured with Photo Research PR-650 Colormeter
2. With a forward current of 20 mA, Absolute Maximum Ratings (Ta=25°C)

Specification:

- 1: TOLERANCES UNLESS OTHERWISE SPECIFIED :  
0~10±0.15, 10~20±0.2, 20~40±0.25,  
40~70±0.3, >70±0.4
- 2: JACK CAVITY CONFORMS TO FCC RULES AND REGULATIONS, PART 68 SUBPART F.



A

A

B

B

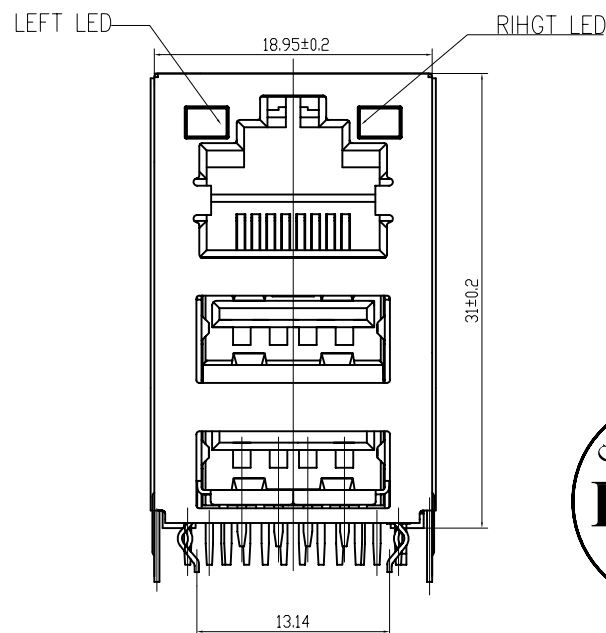
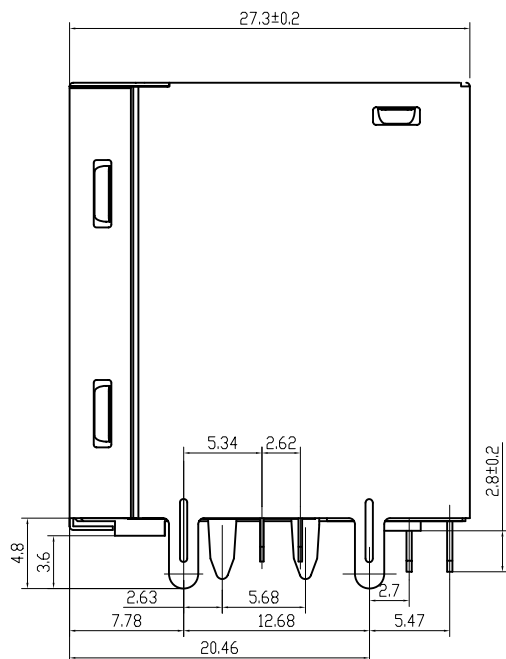

**B-TOP®** 东莞市博腾电子科技有限公司  
Dongguan BroadTop Electronic Technology Co., Ltd.

Designed

MATERIAL

DESCRIPTION

B50(02-11)G8-111-U613-C52(USB+RJ45 GO-Y LED)

Checked

SCALE

2:1

UNIT

mm

MODEL NO.

REV.

V1.0

FIRST ANGLE PROJECTION



TEL: 0769-38926198  
FAX: 0769-38926199  
Website: www.BtopTech.cn  
www.BtopTech.com

Approved

1

2

### DESCRIPTION

RJ45 With internal Magnetics Connector  
 Designe to support such applications as:Ethernet Equipment Complex,Switches,Routers,Firewalls,Servers and Hub  
 Internal magnetics are 100% electrically tested for functionality per IEEE802.3af/at requirement

**ELECTRICAL:** RoHS peak wave solder temperature rating 235℃  
 High performance for maximum EMI suppression  
 350uH minnum OCL with 8mA bias current  
 PoE rating:15W,350mA,48V (For PoE Products only)

JACK CAVITY CONFORMS TO FCC RULES AND REGULATIONS,PART 68 SUBPART F.

**MECHANICAL:**  
 INSERTION FORCE: 2 CONTACTS----350g 4 CONTACTS----500g  
 6 CONTACTS----750g 8 CONTACTS----900g  
 RETENTION STRENGTH: 7.7Kgs BETWEEN JACK AND PLUG  
 DURABILITY: 750 MATING CYCLES Mini

**HOUSING:** 1) GLASS FILLED PA66 (UL 94V-0)  
 2) GLASS FILLED PA46/LCP (UL 94V-0)  
 3) GLASS FILLED PBT (UL 94V-0)

**MATERIAL:**  
**SPRING WIRE:** 1) 0.2-0.45mm DIA PHOSPHOR BRONZE GOLD PLATING OVER NICKEL  
 2) 0.2-0.35mm THICKNESS PHOSPHOR BRONZE ALLOY SELECTIVE GOLD PLATING OVER NICKEL

**SHIELDING:** 0.12-0.24mm THICKNESS COPPER ALLOY WITH TIN PLATED

**GOLD PLATING:** 3μ", 6μ", 15μ", 30μ", 50μ"

**WORKING TEMPERATURE:** -20℃~70℃

**TOLERANCES UNLESS OTHERWISE SPECIFIED :** 0~10±0.15, 10~20±0.2, 20~40±0.25, 40~70±0.3, >70±0.4

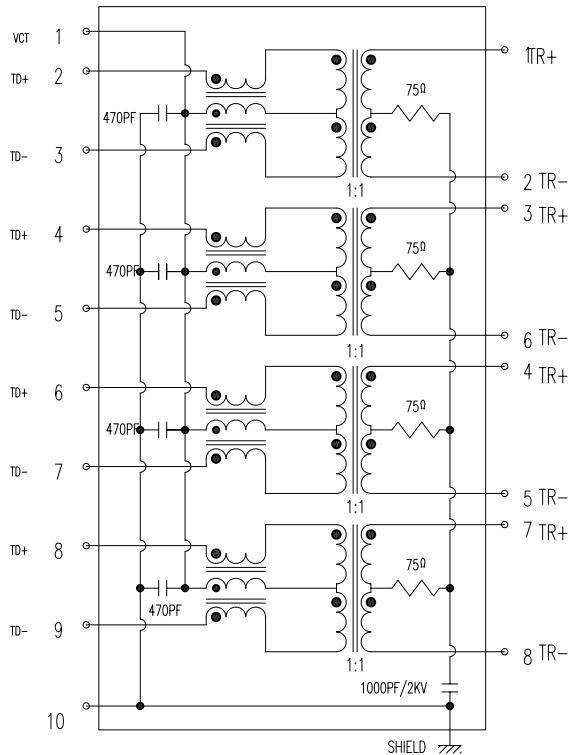
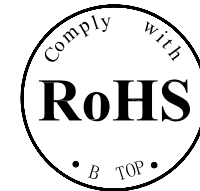

### ELECTRICAL SPECIFICATIONS AT 25 °C

Insertion Loss dB max	Return Loss dB min		Crosstalk(db TYP)	Common Mode Rejection (dB TYP)	Hipot(vrms)
1-125MHz	1-30MHz	30- 80MHz	1- 100MHz	1-100MHz	
-1.2	-18	-18+20log(f/30MHz)	-30	-30	1500/0.5mA OR 2250DC/0.1mA

"B" with the company code

Series of products: 60:Double deck RJ45 connector + transformer series(In sidelong footprint); 59:Double deck RJ45 connector + transformer series(In vertical footprint);50: Single RJ45 + transformer series;52/53/55/56 LED/56/57/59: Ordinary RJ45 series;DX: that strip line series; 40: Conversion said Connectivity 80: Series that UK; 91: Automotive connector public Block;92: Automotive connector mother Block; 93: HDMI the head;94: HDMI mother Block; 95: SMT series; 96: RBS for switches

**Family code (sequence id) :1-99**

Type of product code: G: Gigabit RJ45 transformer; F: 100Base RJ45 transformer; W:for no transformer RJ45 products; W: Series for board-to-board code

**Number of magnetic ring**

**The No. of circuit**

**B N (Z) G X - M - A B C D - E H I**

Product definition LOGO: 1 - Press "B-TOP";2- No "B-TOP"; 3- Other companies LOGO

Product definition plastic materials: 1-PA66,2-PA46, 3-PA, 4-PA6, 5-PBT, 6-ABS, 7-PA9T,8-PC,9-LCP

Pin definition of the product:F-Pin after; B-Pin back; C- No definition of the product

Electroplating product definition: gold-plated terminals(degrees after nickel plated) 1-F μ" ; 2-3 μ" ;3-6 μ" ; 4-15 μ" ; 5-30 μ" ; 6-50 μ" ;7-(N)-50 μ" ;,Sn-80-120 μ" );

Product shielding definition: 0 - no shielding shell; 1 - without shielding shell shrapnel; 2 - shielding a shell shrapnel; 3 - a half-shield shell;

Products luminous definition: 0 - No LED; 1-Left Yellow Right Green; 2 - Left Green Right Yellow; 3 - Double Green; 4 - Double Yellow; 5 - LED straight for the pin; 6 - A special definition;7 - Single linear LEDs

Products out ports: 1-2X1 2-2X2 4-2X4 5-2X5 6-2X6 8-2X8 A-1X1 B-1X2 C-1X4 D-1X5 " E-1X6 F-1X8 U-(USB+RJ45) " P-TAB UP1X1 " H-TAB UP1X2 " K-TAB UP1X4"

**B-TOP®** 东莞博腾电子科技有限公司  
 Dongguan BroadTop Electronic Technology Co., Ltd.

Designed

Checked

Approved

MATERIAL

DESCRIPTION

BT G8-111

FIRST ANGLE PROJECTION

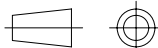

TEL: 0769-38926198  
 FAX: 0769-38926199  
 Website: www.BtopTech.cn  
 www.BtopTech.com

SCALE

1.8:1

UNIT

mm

MODEL NO.

B80020011111

REV.

1.0