

(4 LIGHT PIPE)

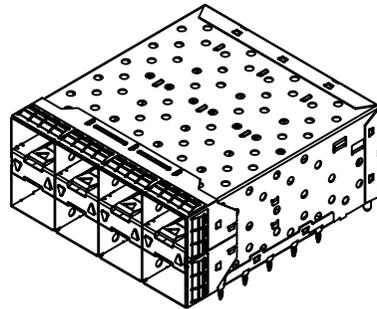

(2 OUTER LIGHT PIPE)

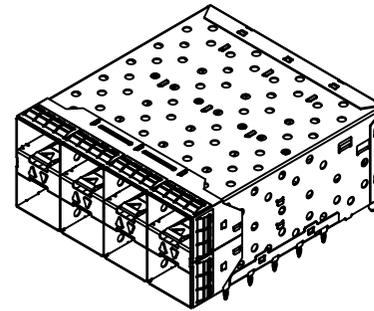

(2 INNER LIGHT PIPE)



NOTES:
MATERIAL:
CAGE: NICKEL SILVER

CONNECTOR:
PLASTIC HOUSING: HIGH TEMPERATURE LCP, UL94 V-0.
LIGHT PIPE: POLYCARBONATE; COLOR: CLEAR
SPRING: STAINLESS STEEL
CONTACTS: PHOSPHOR BRONZE
CONTACT PLATING: 15u" MIN. GOLD ON MATING AREA,
150u" MATTE TIN ON SOLDER TAILS
PACKAGING: TRAY PACKAGING.
TEMPERATURE RANGE: -40 C TO +85 C

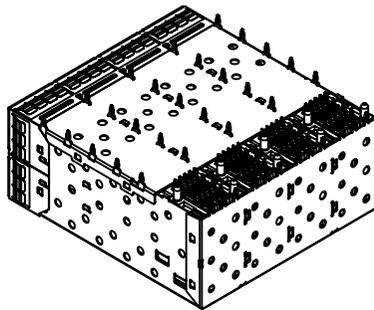

B N (Z) G X - M - A B C D - E H I

"B" with the company code

Series of products: 00: Double deck RJ45 connector + transformer series (in side long footprint); 59: Double deck RJ45 connector + transformer series (in vertical footprint); 50: Single RJ45 + transformer series; 52/53/55/56 LED/56/57/59: Ordinary RJ45 series; 09: thin strip line series; 40: Conversion said Connectivity 80: Series that UK; 91: Automotive connector public Block; 92: Automotive connector mother Block; 93: HDMI the head; 94: HDMI another Block; 95: SMT series; 96: S05 for switches

Family code (sequence id) 1-99

Type of product code: G: Digital RJ45 transformer; F: DOBase RJ45 transformer; P: for transformer RJ45 products; W: Series for board code

Number of magnetic ring
The No. of circuit

Product definition LOGO: 1- Press "B-TOP"; 2- No "B-TOP"; 3- Other companies LOGO

Product definition plastic materials: 1-PA66, 2-PA46, 3-PA, 4-PA6, 5-PBT, 6-ABS, 7-PA9T, 8-PC, 9-LCP

Pin definition of the product: F-Pin after; B-Pin back; C- No definition of the product

Electroplating product definition: gold-plated terminals (degrees after nickel plated) 1-F u", 2-3 u", 3-6 u", 4-15 u", 5-30 u", 6-50 u", 7-(Ni-50 u" Sn-80-120 u")

Product shielding definition: 0 - no shielding shell; 1 - without shielding shell shrapnet; 2 - shielding a shell shrapnet; 3 - a half-shield shell

Products luminous definition: 0 - No LED; 1 - Left Yellow Right Green; 2 - Left Green Right Yellow; 3 - Double Green; 4 - Double Yellow; 5 - LED straight for the pin; 6 - A special definition; 7 - Single linear LEDs

Products out port: 1-2X1 2-2X2 3-2X3 4-2X4 5-2X6 6-2X8 7-1X1 8-1X2 9-1X4 10-1X5 11-1X6 12-1X8 13-1X16 14-1X32 15-1X64 16-1X128

B-TOP® 东莞市博腾电子科技有限公司
Dongguan BroadTop Electronic Technology Co., Ltd.

Designed		MATERIAL		DESCRIPTION	BSFP+(14-01)S-4K24-C92(2X4 SFP+ EMI 屏蔽 透光柱)
Checked		SCALE	1:1.1	UNIT	mm
Approved		MODEL NO.			
					REV. 1.1

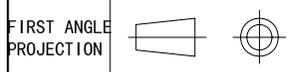

TEL: 0769-38926198
FAX: 0769-38926199
Website: www.BtopTech.cn
www.BtopTech.com

20170818

由 Autodesk 教育版产品制作

由 Autodesk 教育版产品制作

1

2

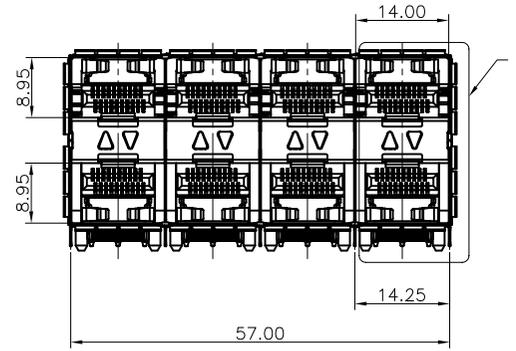
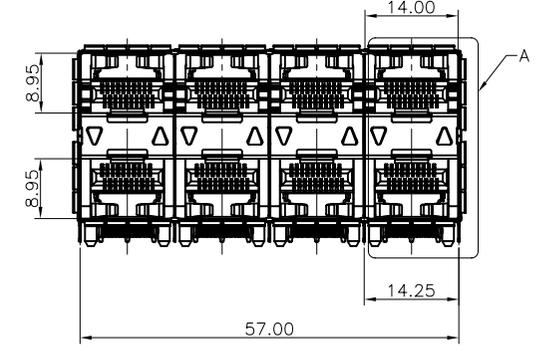
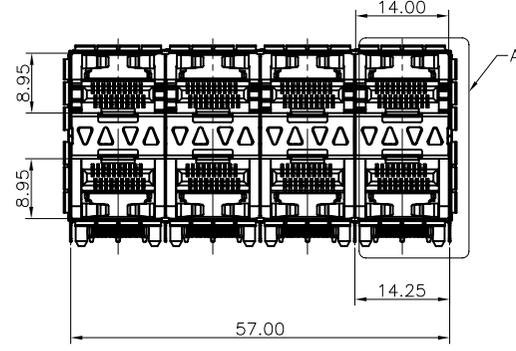
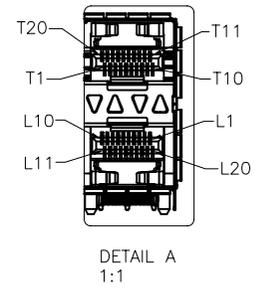
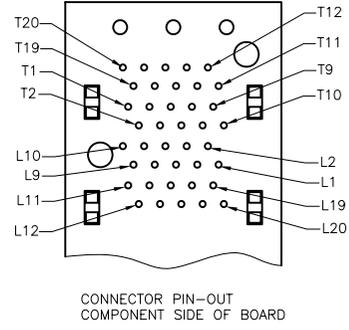
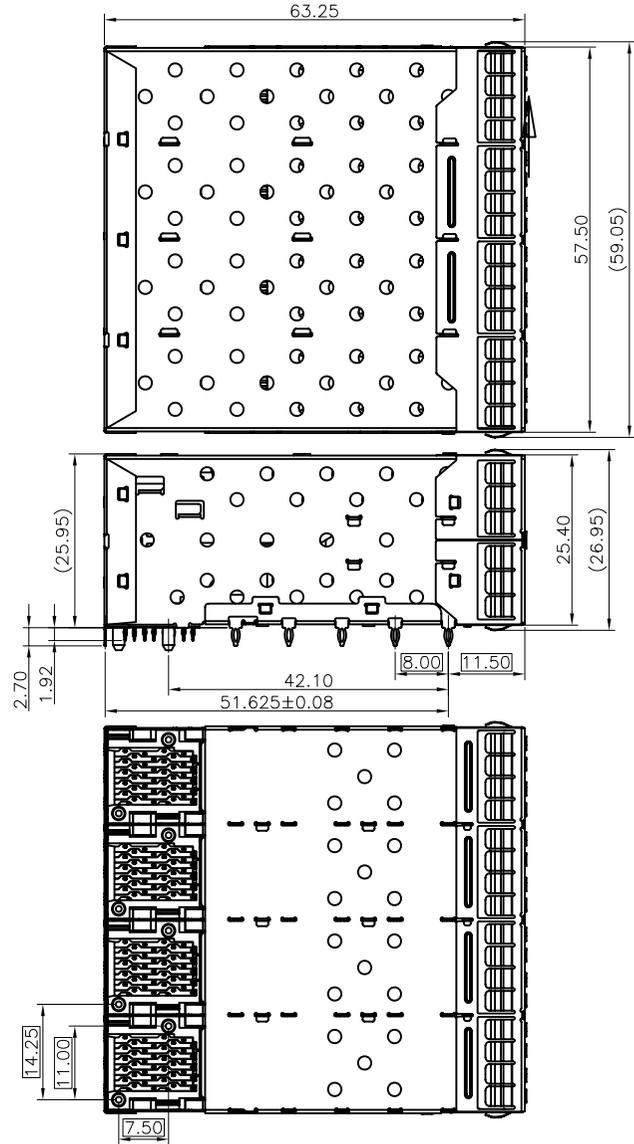

B-TOP® 东莞市博腾电子科技有限公司
Dongguan BroadTop Electronic Technology Co., Ltd.

Designed	MATERIAL	DESCRIPTION	BSFP+(14-01)S-4K24-C92(2X4 SFP+ EMI 屏蔽 透光柱)
Checked	SCALE 1:1.1	UNIT mm	MODEL NO. 4-2
Approved			REV. 1.1

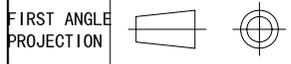

TEL: 0769-38926198
FAX: 0769-38926199
Website: www.BtopTech.cn
www.BtopTech.com

20170818

1

2

由 Autodesk 教育版产品制作

由 Autodesk 教育版产品制作

A

A

B

B

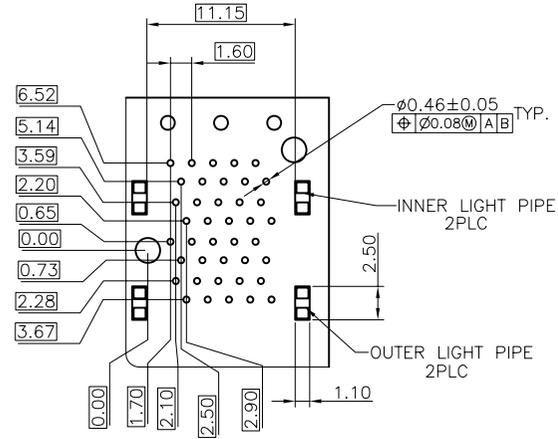
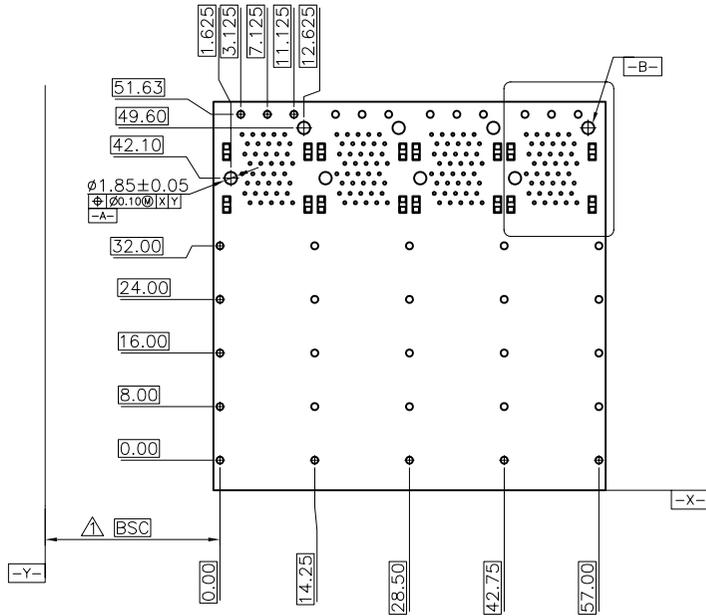
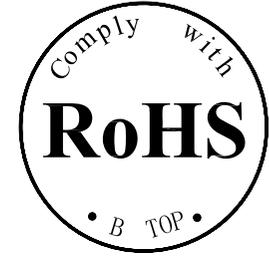

NOTES:

- 1. DATUM AND BASIC DIMENSIONS ESTABLISHED BY CUSTOMER.
- 2. 1.05 mm DIAMETER HOLES ARE CHASSIS GROUND (18 HOLES).

ECOMMENDED PCB CONFIGURATION

B-TOP® 东莞市博腾电子科技有限公司
Dongguan BroadTop Electronic Technology Co., Ltd.

Designed

MATERIAL

DESCRIPTION

BSFP+(14-01)S-4K24-C92(2X4 SFP+ EMI 屏蔽 透光柱)

Checked

SCALE

1:1.1

UNIT

mm

MODEL NO.

4-3

REV.

1.1

FIRST ANGLE PROJECTION



TEL: 0769-38926198
FAX: 0769-38926199
Website: www.BtopTech.cn
www.BtopTech.com

Approved

1

2

A

A

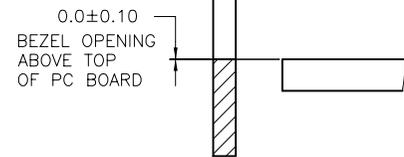
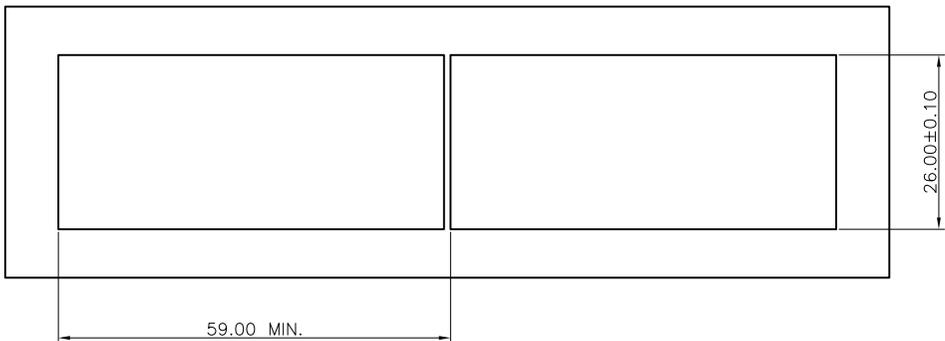
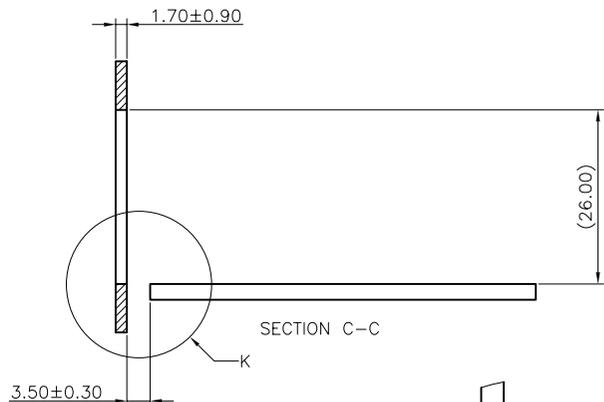
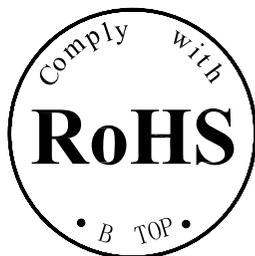
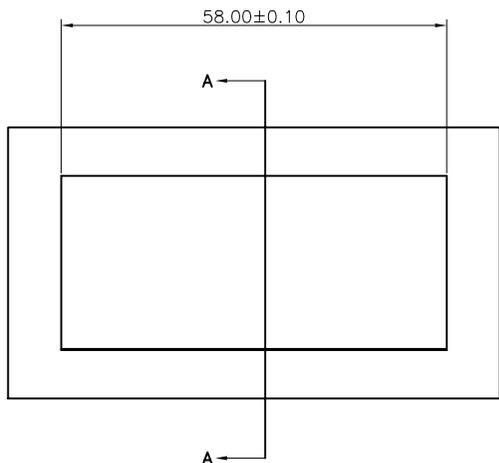

RECOMMENDED BEZEL DESIGN

B

B

B-TOP® 东莞市博腾电子科技有限公司
Dongguan BroadTop Electronic Technology Co., Ltd.

Designed

MATERIAL

DESCRIPTION

BSFP+(14-01)S-4K24-C92(2X4 SFP+ EMI 屏蔽 透光柱)

Checked

SCALE

1:1.1

UNIT

mm

MODEL NO.

4-4

REV.

1.1

FIRST ANGLE PROJECTION



TEL: 0769-38926198
FAX: 0769-38926199
Website: www.BtopTech.cn
www.BtopTech.com

Approved

20170818

1

2