

(4 LIGHT PIPE)

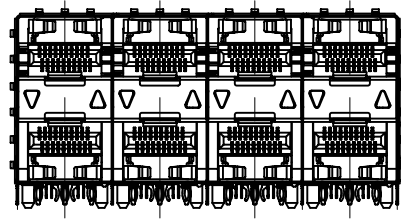

(2 OUTER LIGHT PIPE)

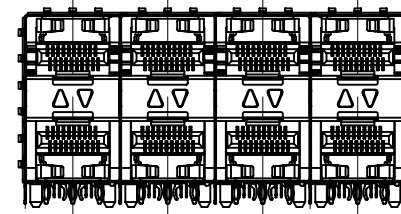

(2 INNER LIGHT PIPE)

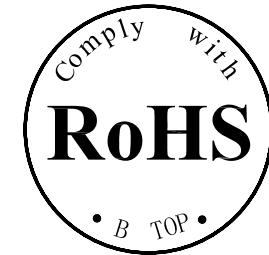

NOTES:  
MATERIAL:  
CAGE: NICKEL SILVER

CONNECTOR:  
PLASTIC HOUSING: HIGH TEMPERATURE LCP, UL94 V-0.  
LIGHT PIPE: POLYCARBONATE; COLOR: CLEAR  
SPRING: STAINLESS STEEL  
CONTACTS: PHOSPHOR BRONZE  
CONTACT PLATING: 15u" MIN. GOLD ON MATING AREA,  
150u" MATTE TIN ON SOLDER TAILS  
PACKAGING: TRAY PACKAGING.  
TEMPERATURE RANGE: -40 C TO +85 C

GROUNDING PIN

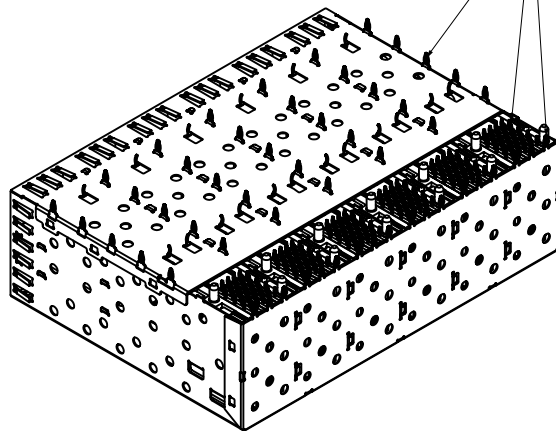

**"B" with the company code**

Series of products: 00: Double deck RJ45 connector + transformer series (in sidelong footprint); 59: Double deck RJ45 connector + transformer series (in vertical footprint); 50: Single RJ45 + transformer series; 52/53/55/56 LED/56/57/59: Ordinary RJ45 series; 09: thin strip line series; 40: Conversion said Connectivity 80: Series that UK; 91: Automotive connector public Block; 92: Automotive connector author Block; 93: HDMI the head; 94: HDMI author Block; 95: SMT series; 96: S05 for switches

**Family code (sequence id) 1-99**

Type of product code: G: Gigabit RJ45 transformer; F: 10Base RJ45 transformer; P: for transformer RJ45 products; W: Series for board-to-board code

**Number of magnetic ring**  
The No. of circuit

Product definition LOGO: 1 - Press "B-TOP"; 2 - No "B-TOP"; 3 - Other companies LOGO

Product definition plastic materials: 1-PA66, 2-PA46, 3-PA, 4-PA6, 5-PBT, 6-ABS, 7-PA9T, 8-PC, 9-LCP

Pin definition of the product: F-Pin after; B-Pin back; C- No definition of the product

Electroplating product definition: gold-plated terminals (degrees after nickel plated) 1-F u", 2-3 u", 3-6 u", 4-15 u", 5-30 u", 6-50 u", 7-(NI-50 u" Sn-80-120 u")

Product shielding definition: 0 - no shielding shell; 1 - without shielding shell shrapnet; 2 - shielding a shell shrapnet; 3 - a half-shield shell

Products luminous definition: 0 - No LED; 1 - Left Yellow Right Green; 2 - Left Green Right Yellow; 3 - Double Green; 4 - Double Yellow; 5 - LED straight for the pin; 6 - A special definition; 7 - Single linear LEDs

Products out port: 1-2X1 2-2X2 3-2X3 4-2X4 5-2X6 6-2X8 7-1X1 8-1X2 9-1X4 10-1X5 11-1X6 12-1X8 13-1X16 14-1X32 15-1X64 16-1X128 17-1X256 18-1X512 19-1X1024 20-1X2048

**B-TOP® 东莞市博腾电子科技有限公司**  
Dongguan BroadTop Electronic Technology Co., Ltd.

Designed: MATERIAL: DESCRIPTION: BSFP(14-02)S-4024-C92(2X4 SFP EMI)

FIRST ANGLE PROJECTION: TEL: 0769-38926198 FAX: 0769-38926199 Website: www.BtopTech.cn www.BtopTech.com

Checked: Approved: SCALE: 1:1.1 UNIT: mm MODEL NO: 4-1 REV: 1.1

由 Autodesk 教育版产品制作

由 Autodesk 教育版产品制作

1

2

A

A

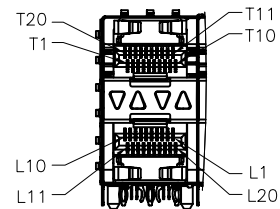
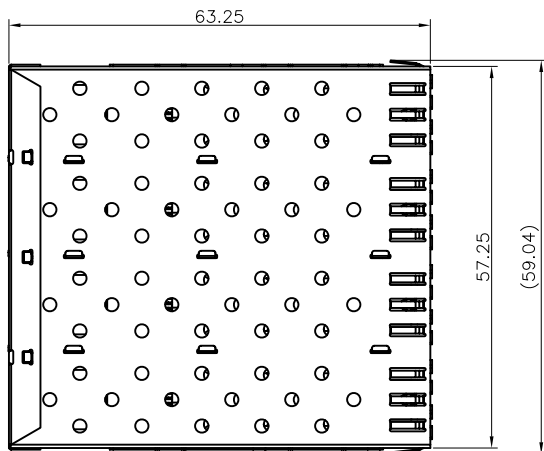

B

B

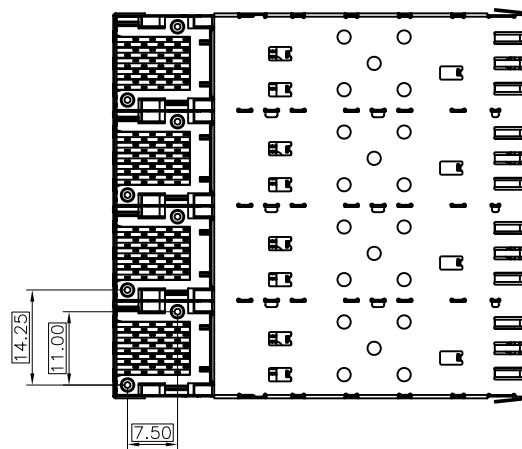
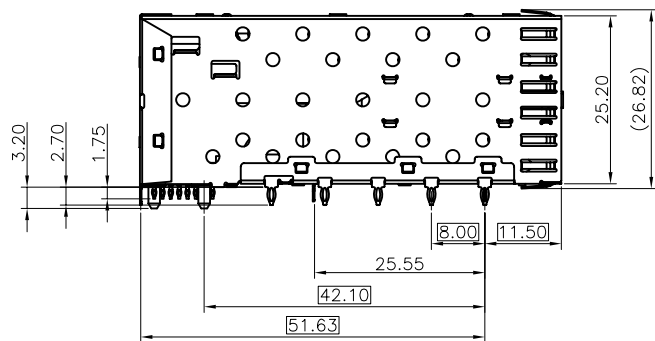

**B-TOP®** 东莞市博腾电子科技有限公司  
Dongguan BroadTop Electronic Technology Co., Ltd.

Designed

MATERIAL

DESCRIPTION

BSFP(14-02)S-4024-C92(2X4 SFP EMI)

Checked

SCALE

1:1.1

UNIT

mm

MODEL NO.

4-2

REV.

1.1

FIRST ANGLE PROJECTION

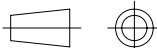

TEL: 0769-38926198  
FAX: 0769-38926199  
Website: www.BtopTech.cn  
www.BtopTech.com

Approved

20170818

1

2

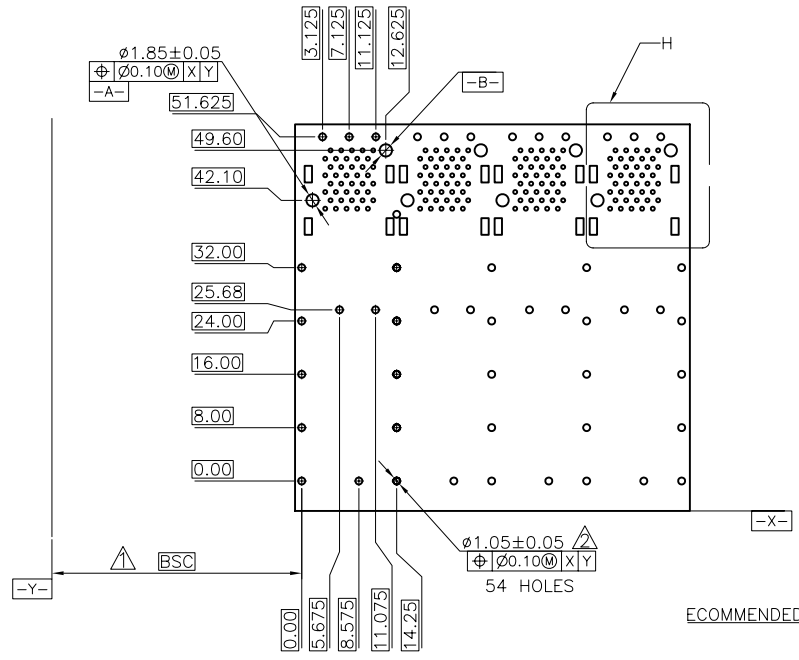

ECOMMENDED PCB CONFIGURATION

NOTES:

- 1. DATUM AND BASIC DIMENSIONS ESTABLISHED BY CUSTOMER.
- 2. 1.05 mm DIAMETER HOLES ARE CHASSIS GROUND (54 HOLES).

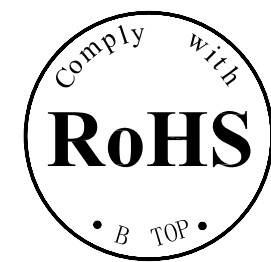
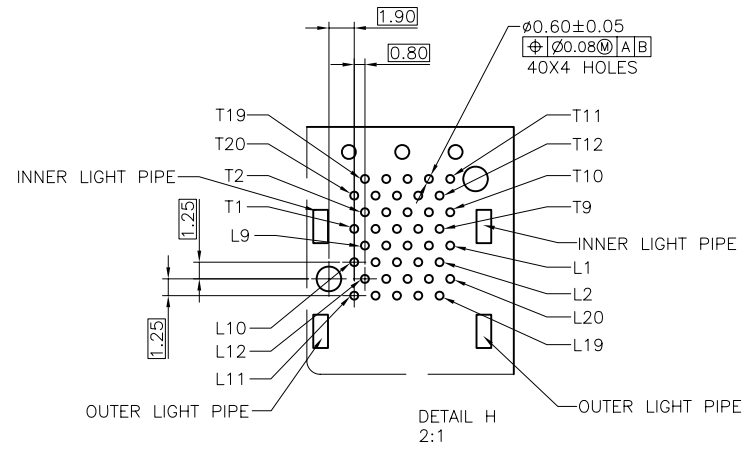

<b>B-TOP®</b> 东莞市博腾电子科技有限公司 Dongguan BroadTop Electronic Technology Co., Ltd.		Designed	MATERIAL		DESCRIPTION		BSFP(14-02)S-4024-C92(2X4 SFP EMI)	
FIRST ANGLE PROJECTION		Checked	SCALE	1:1.1	UNIT	mm	MODEL NO.	4-3
TEL: 0769-38926198	FAX: 0769-38926199	Approved					REV.	1.1
Website: www.BtopTech.cn								

由 Autodesk 教育版产品制作

由 Autodesk 教育版产品制作

A

A

B

B

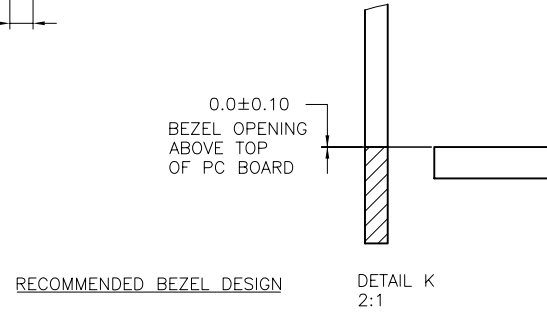
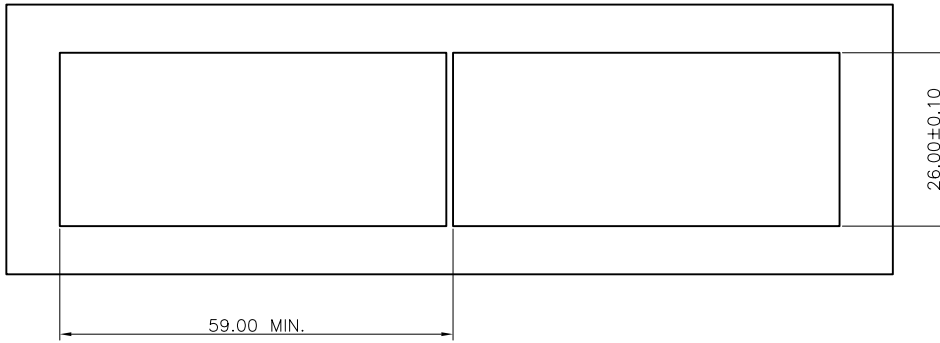
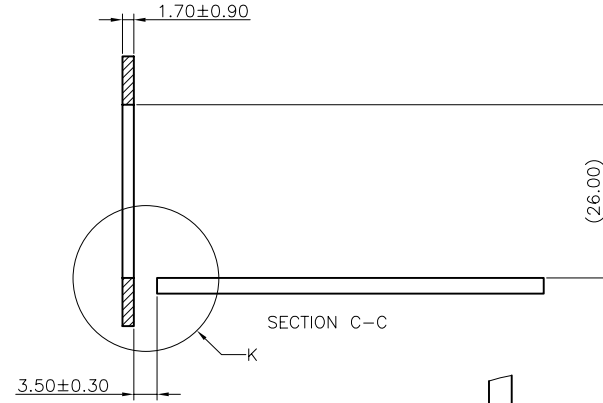
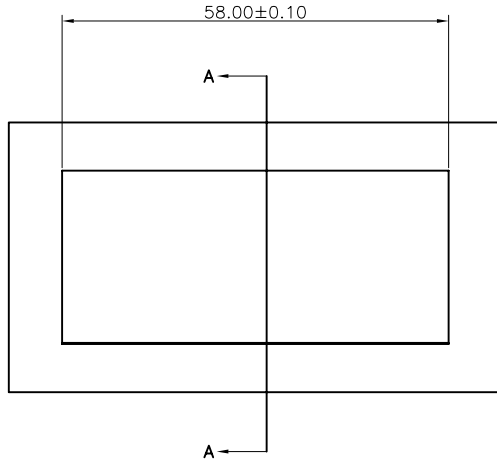
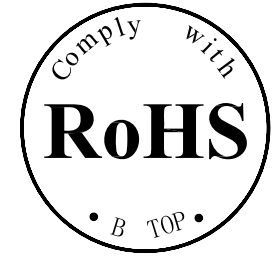

RECOMMENDED BEZEL DESIGN

**B-TOP®** 东莞市博腾电子科技有限公司  
Dongguan BroadTop Electronic Technology Co., Ltd.

Designed  
Checked  
Approved

MATERIAL  
SCALE 1:1.1 UNIT mm MODEL NO.

DESCRIPTION BSFP(14-02)S-4024-C92(2X4 SFP EMI)  
**4-4**  
REV. 1.1

FIRST ANGLE PROJECTION

TEL: 0769-38926198  
FAX: 0769-38926199  
Website: www.BtopTech.cn  
www.BtopTech.com

由 Autodesk 教育版产品制作

由 Autodesk 教育版产品制作

A

A

B

B