

Specification

- 1:TOLERANCES UNLESS OTHERWISE SPECIFIED :
 0~10±0.15、10~20±0.2、20~40±0.25、
 40~70±0.3、≥70±0.4
- 2:JACK CAVITY CONFORMS TO FCC RULES AND REGULATIONS,PART 68 SUBPART F.

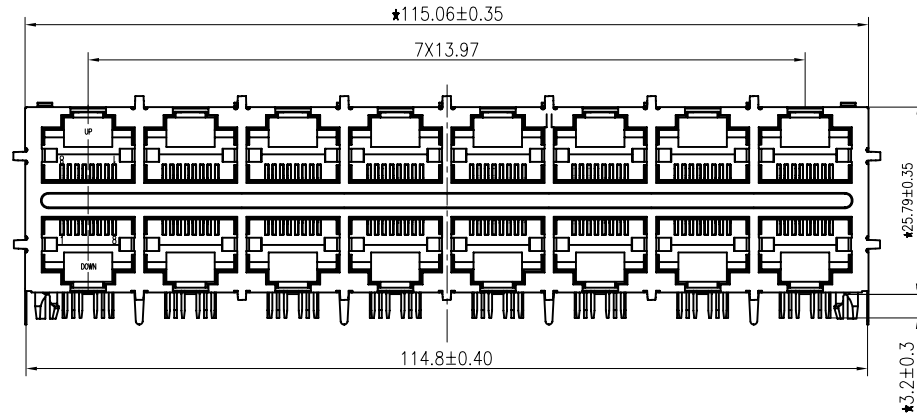
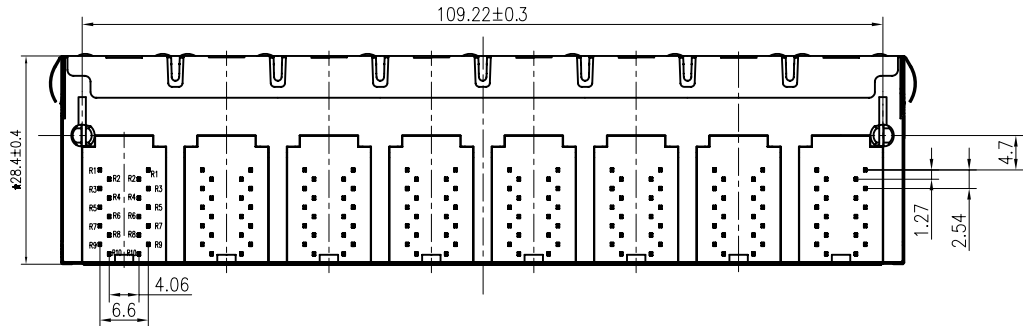
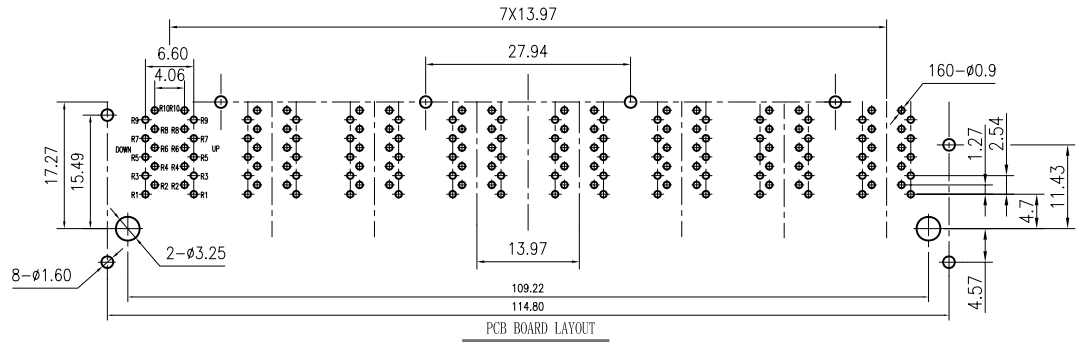
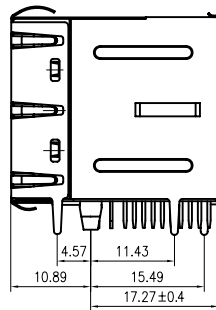

B-TOP® 东莞市博腾电子科技有限公司
 Dongguan BroadTop Electronic Technology Co., Ltd.

Designed

MATERIAL

DESCRIPTION

B59(192-21)G8-10A-8023-C12(2X8 EMI 无LED)

Checked

SCALE

1:1

UNIT

mm

MODEL NO.

REV.

V1.1

FIRST ANGLE PROJECTION

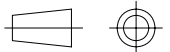

TEL: 0769-38926198

FAX: 0769-38926199

Website

www.BtopTech.cn

www.BtopTech.com

Approved

PCB BOARD LAYOUT

20180411

1

2

SCHEMATIC

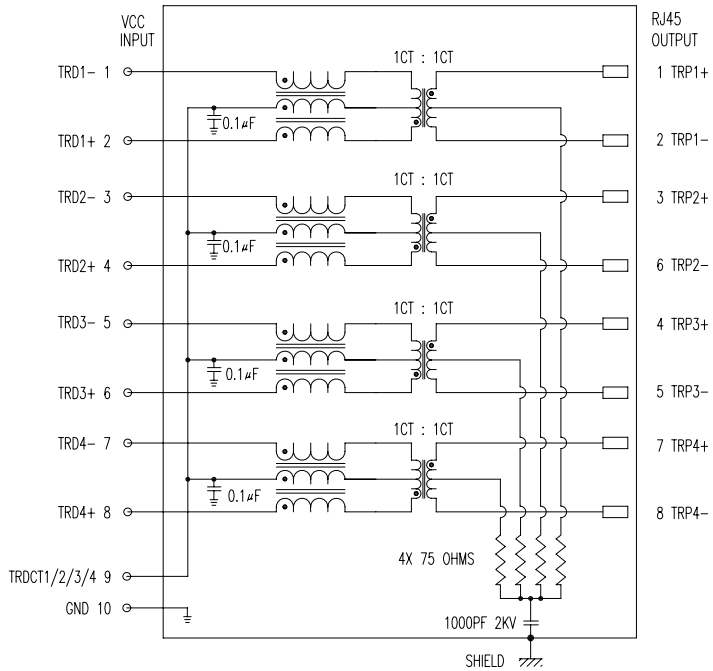

DESCRIPTION

ELECTRICAL: RJ45 With internal Magnetics Connector

Designde to support such applications as:Ethernet Equipment Complex,Switches,Routers,Firewalls,Servers and Hub
 Internal magnetics are 100% electrically tested for functionality per IEEE802.3 requirement
 OCL:100KHz 100mV 8mA 350uH Min; TURNS RATIO:10KHz 1V TRD1/2/3/4 1CT:1CT ±2%
 HI-POT:IN PUT TO OUT PUT 2250V DC 60Sec; OUT PUT TO SHIELD 2250V DC 60Sec
 RoHS peak wave solder temperature rating 260^o 5sec

MECHANICAL: JACK CAVITY CONFORMS TO FCC RULES AND REGULATIONS,PART 68 SUBPART F.

INSERTION FORCE: 8 CONTACTS--900g,10 CONTACTS--1050g
 RETENTION STRENGTH: 7.7Kgs BETWEEN JACK AND PLUG
 DURABILITY: 750 MATING CYCLES Mini

MATERIAL: HOUSING: 1) GLASS FILLED PA66 (UL 94V-0)
 2) GLASS FILLED PA46/PA6T/PA9T/LCP(265^o) (UL 94V-0)
 3) GLASS FILLED PBT/PA/ABS/PC (UL 94V-0)

SPRING WIRE: 0.25-0.35mm THICKNESS PHOSPHOR BRONZE ALLOY ;BOTTOM LAYER NICKEL(30-50^u)
 BETWEEN RIGHT TIN(60-120^u);OVER SELECTIVE GOLD PLATING

GOLD PLATING: 3^u, 6^u, 15^u, 30^u, 50^u

Signal pin: 0.4*0.4 THICKNESS COPPER ALLOY WITH BOTTOM LAYER NI 30~50^u OVER BRIGHT TIN 60~120^u

SHIELDING: 0.2-0.24mm THICKNESS COPPER ALLOY WITH HALF BRIGHT NICKEL(50-100^u) PLATED

Storage: -40^o~85^o Relative Humidity<70%

Operating: -0^o~+70^o

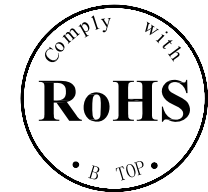

ELECTRICAL SPECIFICATIONS AT 25 °C

Insertion Loss dB max	Return Loss dB min		Crosstalk(db TYP)	Common Mode Rejection (dB TYP)	Hipot(vrms)
1-125MHz	1-30MHz	30- 80MHz	1- 100MHz	1-100MHz	
-1.2	-18	-18+20log(f/30MHz)	-30	-30	1000/0.5mA OR 2000DC/0.1mA

B N (Z) G X - M - A B C D - E H I

"B" with the company code

Series of products: 60:Double deck RJ45 connector + transformer series(In sidelong footprint); 59:Double deck RJ45 connector + transformer series(In vertical footprint);50: Single RJ45 + transformer series;52/53/55/56 LED/56/57/59: Ordinary RJ45 series;DX: that strip line series; 40: Conversion said Connectivity 80: Series that UK; 91: Automotive connector public Block;92: Automotive connector mother Block; 93: HDMI the head;94: HDMI mother Block; 95: SWT series; 96: R/S for switches

Family code (sequence id):1-99

Type of product code: G: Gigabit RJ45 transformer; F: 100Base RJ45 transformer;
 W:for no transformer RJ45 products; M: Series for board-to-board code

Number of magnetic ring

The No. of circuit

Product definition LOGO: 1 - Press "B-TOP";2- No "B-TOP"; 3- Other companes LOGO

Product definition plastic materials: 1-PA66,2-PA46, 3-PA, 4-PA6, 5-PBT, 6-ABS, 7-PA9T,8-PC, 9-LCP

Pin definition of the product:F-Pin after; B-Pin back; C- No definition of the product

Electroplating product definition: gold-plated terminals(degrees after nickel plated) 1-F μ"; 2-3 μ"; 3-6 μ"; 4-15 μ"; 5-30 μ"; 6-50 μ"; 7-(NH-50 μ"; 8-Sn-80-120 μ"; 9-);

Product shielding definition: 0 - no shielding shell; 1 - without shielding shell shrapnel; 2 - shielding a shell shrapnel; 3 - a half-shield shell;

Products luminous definition: 0 - No LED; 1-Left Yellow Right Green; 2 - Left Green Right Yellow; 3 - Double Green; 4 - Double Yellow; 5 - LED straight for the pin; 6 - A special definition;7 - Single linear LEDs

Products out part " 1-2X1" 2-2X2" 4-2X4" 5-2X5" 6-2X6" 6-2X8" A-1X1" B-1X2" C-1X4" D-1X5" E-1X6" T-1X8" U-(USB+RJ45)" P-TAB UP1X1" H-TAB UP1X2" K-TAB UP1X4"

B-TOP® 东莞市博腾电子科技有限公司
 Dongguan BroadTop Electronic Technology Co., Ltd.

Designed

Checked

Approved

MATERIAL

DESCRIPTION

BT G8-10A(三抽头)

FIRST ANGLE PROJECTION

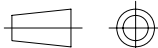

TEL: 0769-38926198
 FAX: 0769-38926199
 Website: www.BtopTech.cn
 www.BtopTech.com

SCALE

1.8:1

UNIT

mm

MODEL NO.

B80020001011

REV.

1.1