

1

2

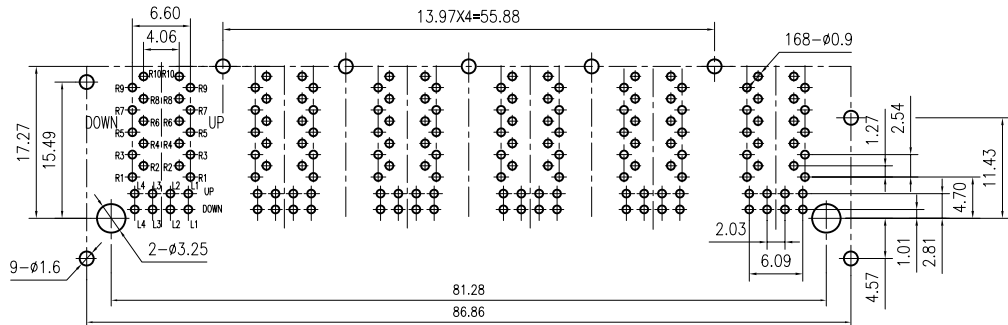

PCB BOARD LAYOUT

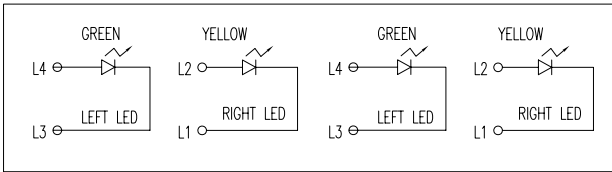
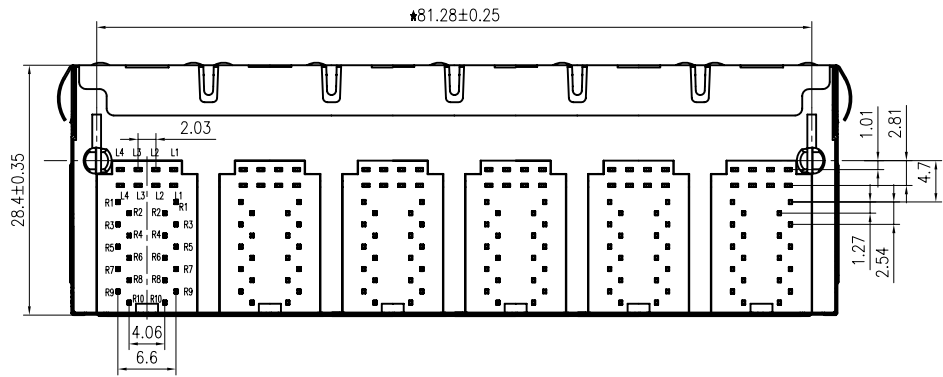

LED Specification

Standard LED Color	LED Wavelength	Forward (V MAX)	Typical (V TYP)	Luminous Intensity
Green	560-580 nm	2.5V	2.1-2.2V	9-25 MCD
Yellow	580-610 nm	2.5V	2.1-2.2V	9-30 MCD
Orange	580-610 nm	2.5V	2.1-2.2V	50-100 MCD

- LED intensity/wavelength measured with Photo Research PR-650 Colormeter
- With a forward current of 20 mA, Absolute Maximum Ratings (Ta=25°C)

- 1: TOLERANCES UNLESS OTHERWISE SPECIFIED :  
 0~10±0.15, 10~20±0.2, 20~40±0.25,  
 40~70±0.3, >70±0.4

- 2: JACK CAVITY CONFORMS TO FCC RULES AND REGULATIONS, PART 68 SUBPART F.

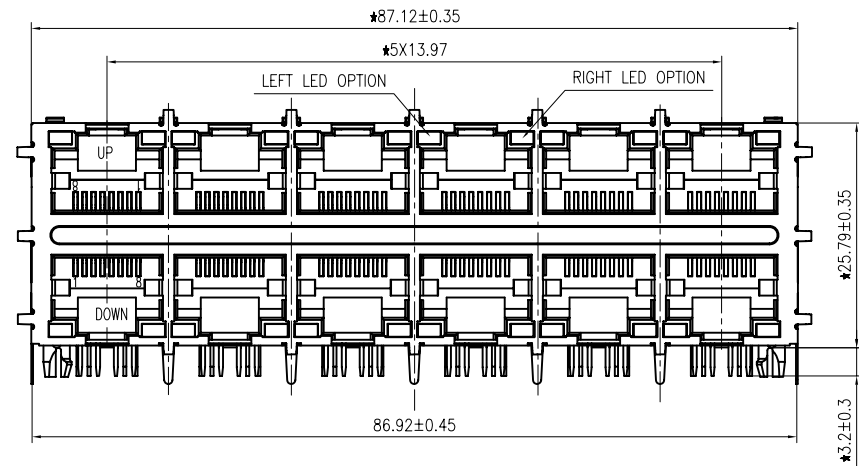
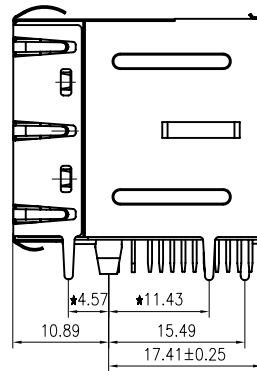

A

A

B

B

**B-TOP**® 东莞市博腾电子科技有限公司  
 Dongguan BroadTop Electronic Technology Co., Ltd.

Designed

MATERIAL

DESCRIPTION

B59(173-39)G8-09B-6223-C12(2X6 G-Y LED EMI -40-+85)

Checked

SCALE

1.2:1

UNIT

mm

MODEL NO.

REV.

V1.0

FIRST ANGLE PROJECTION

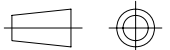

TEL: 0769-38926198  
 FAX: 0769-38926199  
 Website: www.BtopTech.cn  
 www.BtopTech.com

1

2

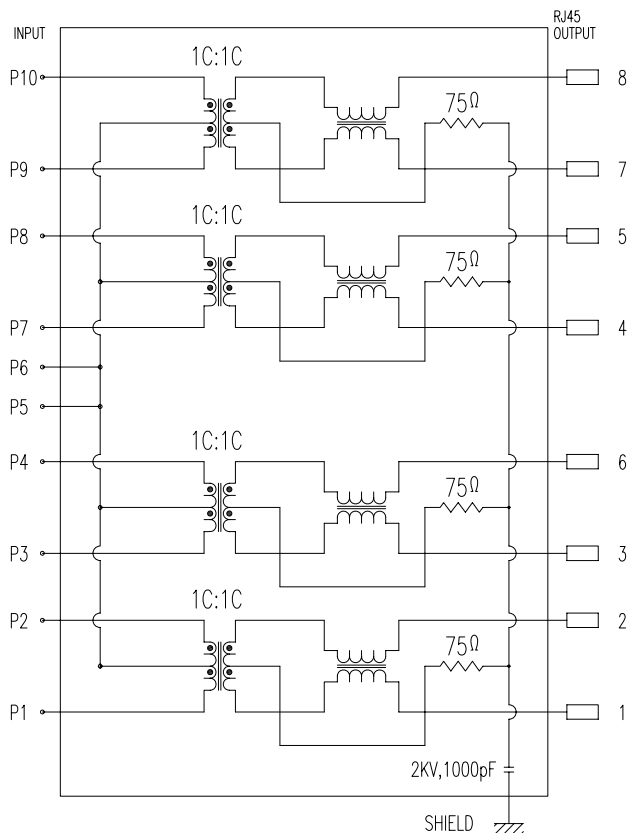

ELECTRICAL SPECIFICATIONS AT 25 °C

Insertion Loss dB max	Return Loss dB min		Crosstalk(db TYP)	Common Mode Rejection (dB TYP)	Hipot(vrms)
1-125MHz	1-30MHz	30- 80MHz	1- 100MHz	1-100MHz	
-1.2	-18	-18+20log(f/30MHz)	-30	-30	1500/0.5mA OR 2250DC/0.1mA

DESCRIPTION

**ELECTRICAL:** RJ45 With internal Magnetics Connector  
 Designe to support such applications as:Ethernet Equipment Complex,Switches,Routers,Firewalls,Servers and Hub  
 Internal magnetics are 100% electrically tested for functionality per IEEE802.3 requirement  
 RoHS peak wave solder temperature rating 235℃  
 High performance for maximum EMI suppression  
 350uH minnum OCL with 8mA bias current

**MECHANICAL:** JACK CAVITY CONFORMS TO FCC RULES AND REGULATIONS,PART 68 SUBPART F.

INSERTION FORCE: 2 CONTACTS----350g 4 CONTACTS----500g  
 6 CONTACTS----750g 8 CONTACTS----900g  
 10 CONTACTS----1050g

RETENTION STRENGTH: 7.7Kgs BETWEEN JACK AND PLUG  
 DURABILITY: 750 MATING CYCLES Mini

**MATERIAL:** HOUSING: 1) GLASS FILLED PA66 (UL 94V-0)  
 2) GLASS FILLED PA46/PA6T/PA9T/LCP (UL 94V-0)  
 3) GLASS FILLED PBT/PA/ABS/PC (UL 94V-0)

SPRING WIRE: 0.2-0.35mm THICKNESS PHOSPHOR BRONZE ALLOY SELECTIVE GOLD PLATING OVER NICKEL

SHIELDING: 0.12-0.24mm THICKNESS COPPER ALLOY WITH TIN PLATED

GOLD PLATING: 3μ", 6μ", 15μ", 30μ", 50μ"

WORKING TEMPERATURE: -40℃~85℃

TOLERANCES UNLESS OTHERWISE SPECIFIED : 0~10±0.15, 10~20±0.2, 20~40±0.25, 40~70±0.3, >70±0.4



B N (Z) G X- M - A B C D - E H I

"B" with the company code

Series of products: 60:Double deck RJ45 connector + transformer series(In sidelong footprint); 69:Double deck RJ45 connector + transformer series(In vertical footprint); 50: Single RJ45 + transformer series;52/53/55/56 LED/56/57/59; Ordinary RJ45 series;DX: that strip line series; 40: Conversion said Connectivity 80: Series that UK; 91: Automotive connector public Block;92: Automotive connector mother Block;93: HDMI the head;94: HDMI mother Block; 95: SMT series; 96: RIBS for switches

Family code (sequence id):1-99

Type of product code: G: Gigabit RJ45 transformer; F: 100Base RJ45 transformer; E: for no transformer RJ45 products; M: Series for board-to-board code

Number of magnetic ring

The No. of circuit

Product definition LOGO: 1- Press LOGO ;2-No LOGO ;3- Other companies LOGO

Product definition plastic materials: 1-PA66,2-PA46, 3-PA, 4-PA6, 5-PBT, 6-ABS, 7-PA9T,8-PC,9-LCP

Pin definition of the product:F-Pin after; B-Pin back; C- No definition of the product

Electroplating product definition: gold-plated terminals(degrees after nickel plated) 1-F μ"; 2-3 μ"; 3-6 μ"; 4-15 μ"; 5-30 μ"; 6-50 μ"; 7-1Ni-50 μ"; ,Sn-80-120 μ");

Product shielding definition: 0 - no shielding shell; 1 - without shielding shell shrapnet; 2 - shielding a shell shrapnet; 3 - a half-shield shell; 4 - TF5-shield shell

Products Luminous definition: 0 - No LED; 1-Left Yellow Right Green; 2- Left Green Right Yellow; 3 - Double Green; 4 - Double Yellow; 5- LED straight for the pin; 6 - A special definition;7 - Single linear LEDs

Products out part " 1=2X1" 2=2X2" 4=2X4" 5=2X5" 6=2X6" 8=2X8" A=1X1" B=1X2" C=1X4" D=1X5 " E=1X6" T=1X8" U=USB+RJ45" P=TAB UP1X1" H=TAB UP1X2" K=TAB UP1X4"

A

A

B

B

**B-TOP®** 东莞市博腾电子科技有限公司  
 Dongguan BroadTop Electronic Technology Co., Ltd.

Designed

Checked

Approved

MATERIAL

DESCRIPTION

BT G8-09B -40-+85

FIRST ANGLE PROJECTION



TEL: 0769-38926198  
 FAX: 0769-38926199  
 Website: www.BtopTech.cn  
 www.BtopTech.com

SCALE

1.8:1

UNIT

mm

MODEL NO.

B80020000911

REV.