

1

2

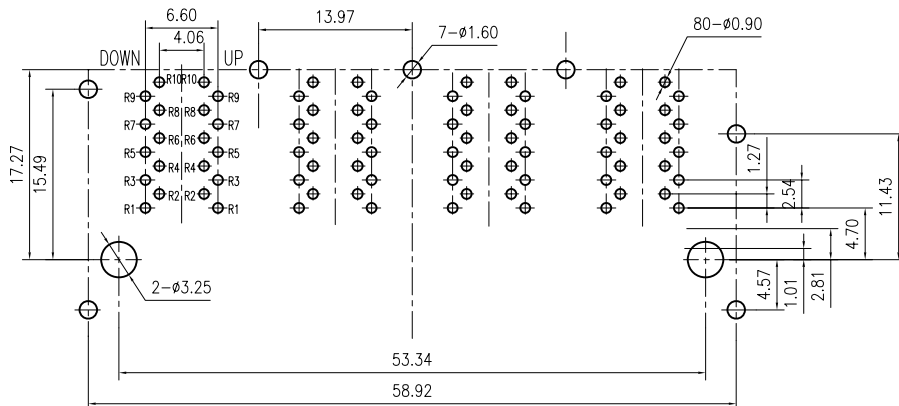

PCB BOARD LAYOUT

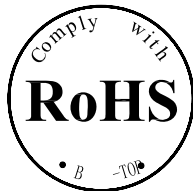
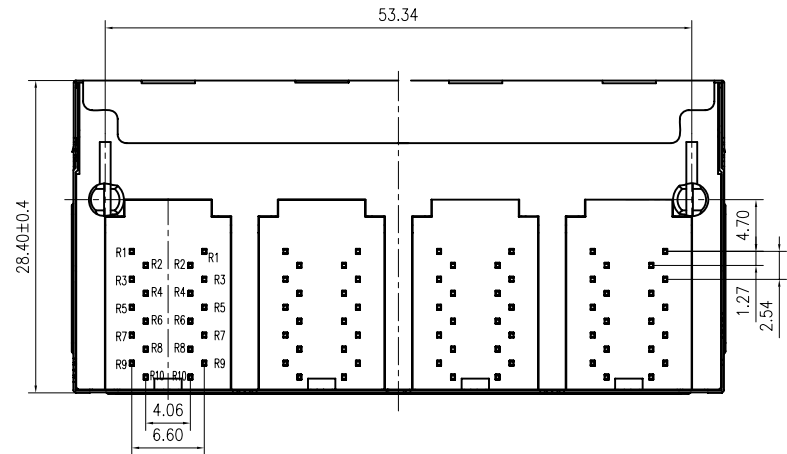

1:TOLERANCES UNLESS OTHERWISE SPECIFIED :  
 0~10±0.15、10~20±0.2、20~40±0.25、  
 40~70±0.3、≥70±0.4  
 2:JACK CAVITY CONFORMS TO FCC RULES AND  
 REGULATIONS,PART 68 SUBPART F.

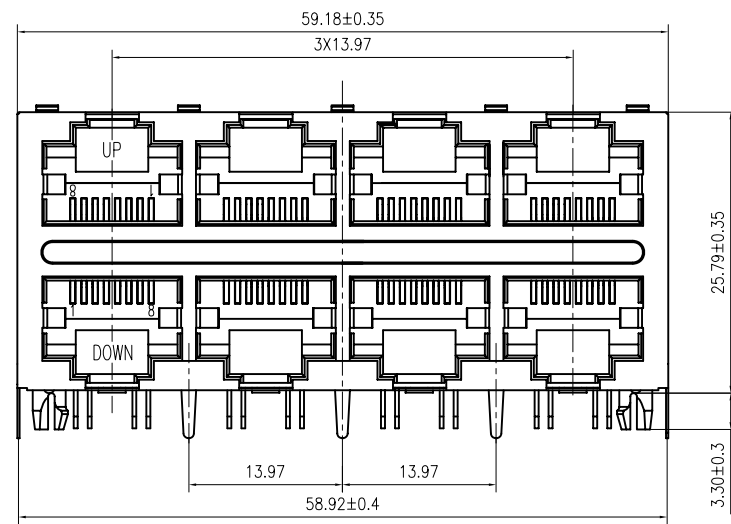
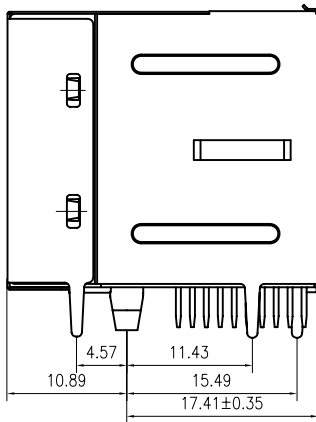

**B-TOP**® 东莞市博腾电子科技有限公司  
 Dongguan BroadTop Electronic Technology Co., Ltd.

Designed  
 Checked  
 Approved

MATERIAL  
 SCALE 1.5:1 UNIT mm MODEL NO.

DESCRIPTION B59(117-07)F4-41-4012-C12(2X4 )  
 REV.

FIRST ANGLE PROJECTION

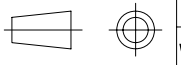

TEL: 0769-38926198  
 FAX: 0769-38926199  
 Website: www.BtopTech.cn  
 www.BtopTech.com

1

2

### DESCRIPTION

RJ45 With internal Magnetics Connector

Designde to support such applications as:Ethernet Equipment Complex,Switches,Routers,Firewalls,Servers and Hub  
Internal magnetics are 100% electrically tested for functionality per IEEE802.3af/at requirement

**ELECTRICAL:** RoHS peak wave solder temperature rating 235℃  
High performance for maximum EMI suppression  
350uH minnum OCL with 8mA bias current  
PoE rating:15W,350mA,48V (For PoE Products only)

JACK CAVITY CONFORMS TO FCC RULES AND REGULATIONS,PART 68 SUBPART F.

**MECHANICAL:**  
INSERTION FORCE: 2 CONTACTS----350g 4 CONTACTS----500g  
6 CONTACTS----750g 8 CONTACTS----900g  
10 CONTACTS----1050g  
RETENTION STRENGTH: 7.7Kgs BETWEEN JACK AND PLUG  
DURABILITY: 750 MATING CYCLES Mini

**HOUSING:** 1) GLASS FILLED PA66 (UL 94V-0)  
2) GLASS FILLED PA46/LCP (UL 94V-0)  
3) GLASS FILLED PBT (UL 94V-0)

**MATERIAL:**  
SPRING WIRE: 1) 0.2-0.45mm DIA PHOSPHOR BRONZE GOLD PLATING OVER NICKEL  
2) 0.2-0.35mm THICKNESS PHOSPHOR BRONZE ALLOY SELECTIVE GOLD PLATING OVER NICKEL

SHIELDING: 0.12-0.24mm THICKNESS COPPER ALLOY WITH TIN PLATED

GOLD PLATING: 3μ", 6μ", 15μ", 30μ", 50μ"

WORKING TEMPERATURE: -20℃~70℃

TOLERANCES UNLESS OTHERWISE SPECIFIED : 0~10±0.15、10~20±0.2、20~40±0.25、40~70±0.3、>70±0.4

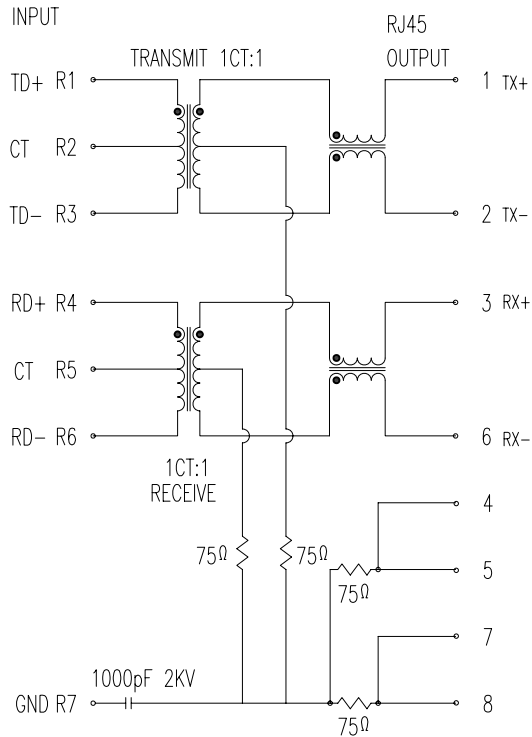

### ELECTRICAL SPECIFICATIONS AT 25 °C

Insertion Loss dB max	Return Loss dB min		Crosstalk(db TYP)	Common Mode Rejection (dB TYP)	Hipot(vrms)
	1-125MHz	30- 80MHz			
-1.2	-18	-18+20log(f/30MHz)	-30	-30	1500/0.5mA OR 2250DC/0.1mA

"B" with the company code

Series of products: 60:Double deck RJ45 connector + transformer series(In sidelong footprint); 39:Double deck RJ45 connector + transformer series(In vertical footprint);50: Single RJ45 + transformer series;52/53/55/56 LED/56/57/59: Ordinary RJ45 series;DX: that strip line series; 40: Conversion said Connectivity 80: Series that UK; 91: Automotive connector public Block;92: Automotive connector mother Block; 93: HDMI the head;94: HDMI mother Block; 95: SMT series; 96: RBIS for switches

Family code (sequence id) :1-99

Type of product code: G: Gigabit RJ45 transformer; F: 100Base RJ45 transformer; W: for no transformer RJ45 products; M: Series for board-to-board code

Number of magnetic ring

The No. of circuit

B N (Z) G X - M - A B C D - E H I

Product definition LOGO: 1 - Press "B-TOP"; 2- No "B-TOP"; 3- Other companies LOGO

Product definition plastic materials: 1-PA66,2-PA46, 3-PA, 4-PA6, 5-PBT, 6-ABS, 7-PA9T,8-PC,9-LCP

Pin definition of the product:F-Pin after; B-Pin back; C- No definition of the product

Electroplating product definition: gold-plated terminals(degrees after nickel plated) 1-F μ " ; 2-3 μ " ; 3-6 μ " ; 4-15 μ " ; 5-30 μ " ; 6-50 μ " ; 7-(Ni-50 μ " ; Sn-80-120 μ " ) ;

Product shielding definition: 0 - no shielding shell; 1 - without shielding shell shrapnet; 2 - shielding a shell shrapnet; 3 - a half-shield shell;

Products luminous definition: 0 - No LED; 1 -Left Yellow Right Green; 2 - Left Green Right Yellow; 3 - Double Green; 4 - Double Yellow; 5 - LED straight for the pin; 6 - A special definition;7 - Single linear LEDs

Products out port " 1-2X1" 2-2X2" 4-2X4" 5-2X5" 6-2X6" 8-2X8" A-1X1" B-1X2" C-1X4" D-1X5" E-1X6" T-1X8" U-(USB+RJ45)" P-TAB UP1X1" H-TAB UP1X2" K-TAB UP1X4"

**B-TOP®** 东莞市博腾电子科技有限公司  
Dongguan BroadTop Electronic Technology Co., Ltd.

Designed

Checked

Approved

MATERIAL

DESCRIPTION

BT F4-41

FIRST ANGLE PROJECTION

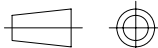

TEL: 0769-38926198  
FAX: 0769-38926199  
Website: www.BtopTech.cn  
www.BtopTech.com

SCALE

1.8:1

UNIT

mm

MODEL NO.

REV.