

1

2

A

A

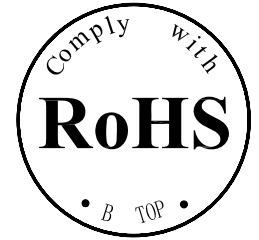
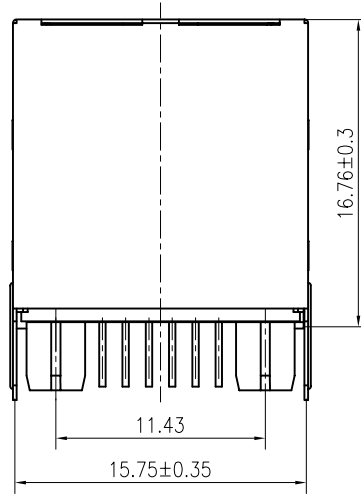
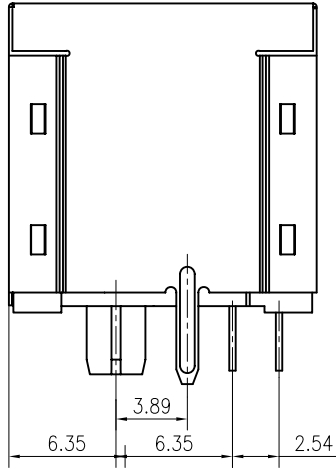

B

B

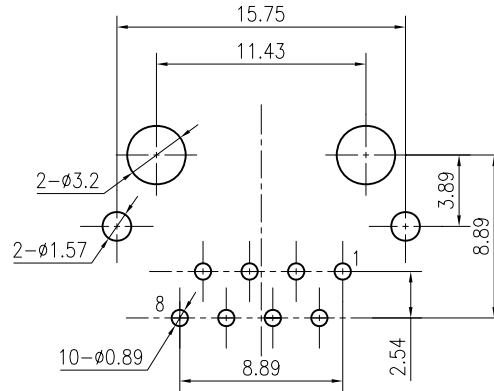
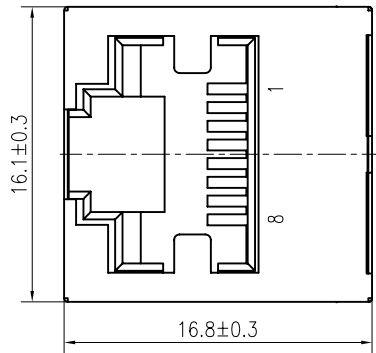

PCB BOARD LAYOUT

Specification:

1:TOLERANCES UNLESS OTHERWISE SPECIFIED :
 0~10±0.15、10~20±0.2、20~40±0.25、
 40~70±0.3、≥70±0.4

2:JACK CAVITY CONFORMS TO FCC RULES AND
 REGULATIONS,PART 68 SUBPART F.

B-TOP® 东莞市博腾电子科技有限公司
 Dongguan BroadTop Electronic Technology Co., Ltd.

Designed

MATERIAL

DESCRIPTION

B50(512-09)F4-03A-A013-B52(5224-D 1X1)

Checked

SCALE

2.5:1

UNIT

mm

MODEL NO.

REV.

V1.0

FIRST ANGLE
 PROJECTION

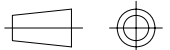

TEL: 0769-38926198

FAX: 0769-38926199

Website

www.BtopTech.cn
 www.BtopTech.com

1

2

DESCRIPTION

RJ45 With internal Magnetics Connector
 Designed to support such applications as:Ethernet Equipment Complex,Switches,Routers,Firewalls,Servers and Hub
 Internal magnetics are 100% electrically tested for functionality per IEEE802.3af/at requirement

ELECTRICAL: RoHS peak wave solder temperature rating 235℃
 High performance for maximum EMI suppression
 350uH minnum OCL with 8mA bias current
 PoE rating:15W,350mA,48V (For PoE Products only)

JACK CAVITY CONFORMS TO FCC RULES AND REGULATIONS,PART 68 SUBPART F.

MECHANICAL: INSERTION FORCE: 2 CONTACTS----350g 4 CONTACTS----500g
 6 CONTACTS----750g 8 CONTACTS----900g
 RETENTION STRENGTH: 7.7Kgs BETWEEN JACK AND PLUG
 DURABILITY: 750 MATING CYCLES Mini

MATERIAL: HOUSING: 1) GLASS FILLED PA66 (UL 94V-0)
 2) GLASS FILLED PA46/LCP (UL 94V-0)
 3) GLASS FILLED PBT (UL 94V-0)
 SPRING WIRE: 1) 0.2-0.45mm DIA PHOSPHOR BRONZE GOLD PLATING OVER NICKEL
 2) 0.2-0.35mm THICKNESS PHOSPHOR BRONZE ALLOY SELECTIVE GOLD PLATING OVER NICKEL
 SHIELDING: 0.12-0.24mm THICKNESS COPPER ALLOY WITH TIN PLATED
 GOLD PLATING: 3μ", 6μ", 15μ", 30μ", 50μ"
 WORKING TEMPERATURE: -20℃~70℃
 TOLERANCES UNLESS OTHERWISE SPECIFIED : 0~10±0.15、10~20±0.2、20~40±0.25、40~70±0.3、>70±0.4

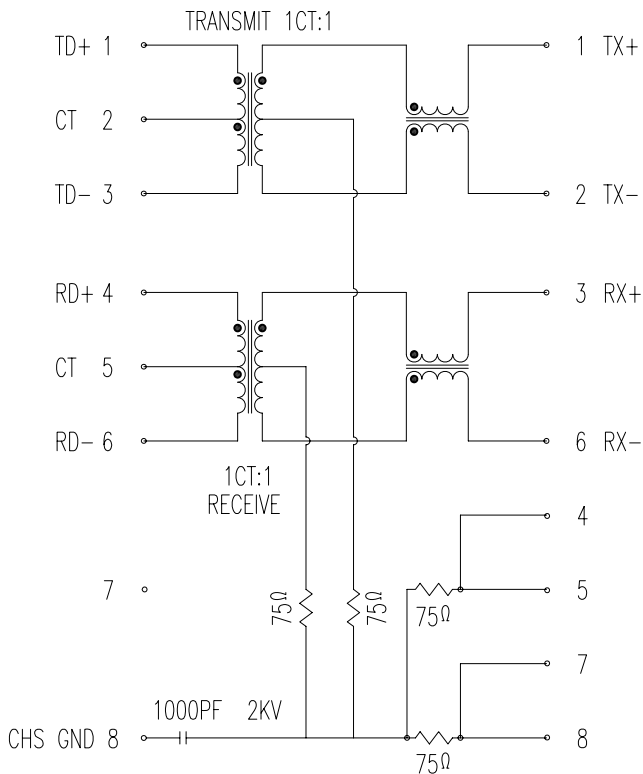

ELECTRICAL SPECIFICATIONS AT 25°C

Insertion Loss dB max	Return Loss dB min		Crosstalk(db TYP)	Common Mode Rejection (dB TYP)	Hipot(vrms)
	1-30MHz	30- 80MHz			
1-125MHz	1-30MHz	30- 80MHz	1- 100MHz	1-100MHz	
-1.2	-18	-18+20log(f/30MHz)	-30	-30	1500/0.5mA OR 2250DC/0.1mA

"B" with the company code

Series of products: 60:Double deck RJ45 connector + transformer series(In sidelong footprint); 59:Double deck RJ45 connector + transformer series(In vertical footprint);50: Single RJ45 + transformer series;52/53/55/56 LED/56/57/59: Ordinary RJ45 series;DX: that strip line series; 40: Conversion said Connectivity 80: Series that UK; 91: Automotive connector public Block;92: Automotive connector mother Block; 93: HDMI the head;94: HDMI mother Block; 95: SWI series; 96: RBS for switches

Family code (sequence id) :1-99

Type of product code: G: Gigabit RJ45 transformer; F: 100Base RJ45 transformer; W: for no transformer RJ45 products; M: Series for board-to-board code

Number of magnetic ring

The No. of circuit

Product definition LOGO: 1 - Press "B" - TOP
 ";2- No "B" - TOP"; 3- Other companies LOGO

Product definition plastic materials: 1-PA66,2-PA46, 3-PA, 4-PA6, 5-PBT, 6-ABS, 7-PA9T,8-PC,9-LCP

Pin definition of the product:F-Pin after; B-Pin back; C- No definition of the product

Electroplating product definition: gold-plated terminals(degrees after nickel plated) 1-F μ " ; 2-3 μ " ;3-6 μ " ;4-15 μ " ;5-30 μ " ;6-50 μ " ;7-(Ni-50 μ " ;Sn-80-120 μ ");

Product shielding definition: 0 - no shielding shell; 1 - without shielding shell shrapnel; 2 - shielding a shell shrapnel; 3 - a half-shield shell;

Products luminous definition: 0 - No LED; 1-Left Yellow Right Green; 2 - Left Green Right Yellow; 3 - Double Green; 4 - Double Yellow; 5 - LED straight for the pin; 6 - A special definition;7 - Single linear LEDs

Products out port" 1-2X1" 2-2X2" 4-2X4" 5-2X5" 6-2X6" 8-2x8" A-1X1" B-1X2" C-1X4" D-1X5 " E-1X6" I-1X8" U-(USB+RJ45)" P-TAB UP1X1" H-TAB UP1X2" K-TAB UP1X4"

B-TOP® 东莞市博腾电子科技有限公司
 Dongguan BroadTop Electronic Technology Co., Ltd.

Designed

Checked

Approved

MATERIAL

DESCRIPTION

BT F4-03A

FIRST ANGLE PROJECTION

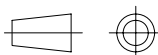

TEL: 0769-38926198
 FAX: 0769-38926199
 Website: www.BtopTech.cn
 www.BtopTech.com

SCALE

1.8:1

UNIT

mm

MODEL NO.

B80010000311

REV.