

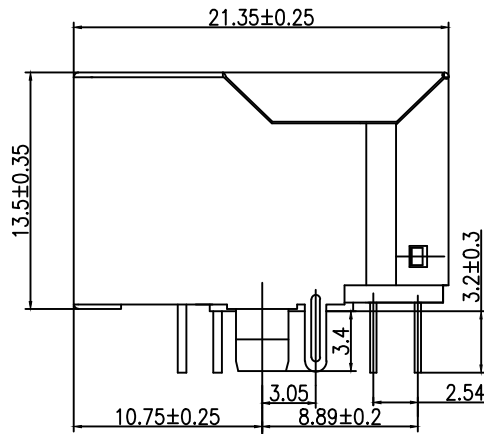

LIFT LED GREEN
RIGHT LED YELLOW

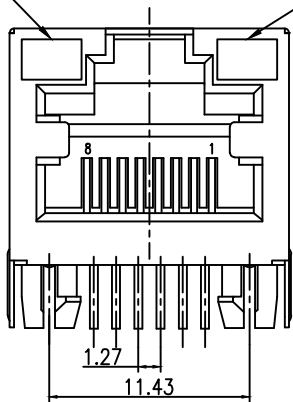

DESCRIPTION:
RJ45 With internal Magnetics Connector
Designed to support such applications as: Ethernet Equipment Complex, Switches, Routers, Firewalls, Servers and Hub
Internal magnetics are 100% electrically tested for functionality per IEEE802.3af/at requirement

ELECTRICAL:
RoHS peak wave solder temperature rating 235°C
High performance for maximum EMI suppression
JACK CAVITY CONFORMS TO FCC RULES AND REGULATIONS, PART 68 SUBPART F.

INSERTION FORCE:
2 CONTACTS----350g 4 CONTACTS----500g
6 CONTACTS----750g 8 CONTACTS----900g
10 CONTACTS----1050g

MECHANICAL:
RETENTION STRENGTH: 7.7Kgs BETWEEN JACK AND PLUG
DURABILITY: 750 MATING CYCLES Mini
HOUSING: 1) GLASS FILLED PBT (UL 94V-0)
2) GLASS FILLED PBT (UL 94V-0)

MATERIAL:
SPRING WIRE:
1) 0.2-0.45mm DIA PHOSPHOR BRONZE GOLD PLATING OVER NICKEL
2) 0.2-0.35mm THICKNESS PHOSPHOR BRONZE ALLOY SELECTIVE GOLD PLATING OVER NICKEL;
GOLD PLATING: 3μ", 6μ", 15μ", 30μ", 50μ"
TOLERANCES UNLESS OTHERWISE SPECIFIED :
0-10±0.15, 10-20±0.2, 20-40±0.25, 40-70±0.3, ≥70±0.4

1. Recommend Plug Dim

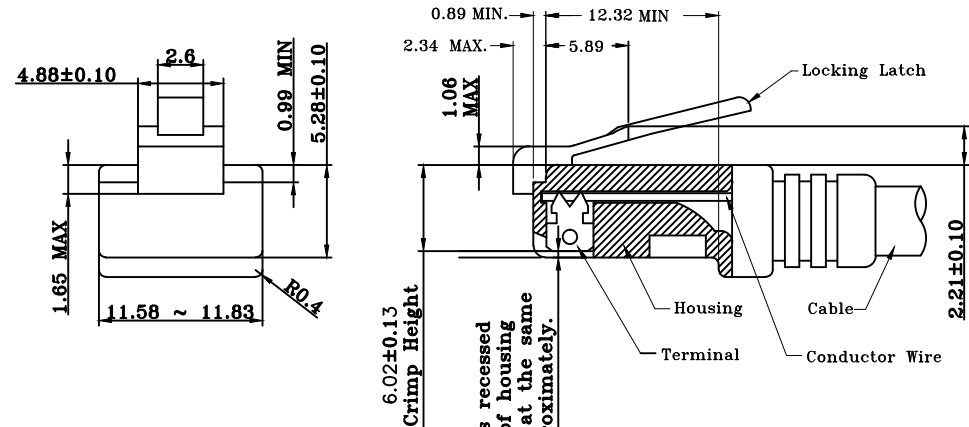
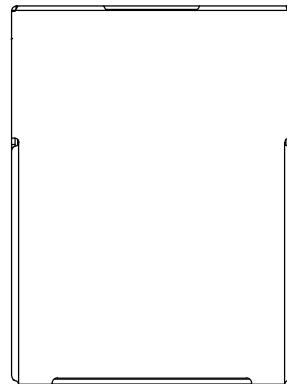
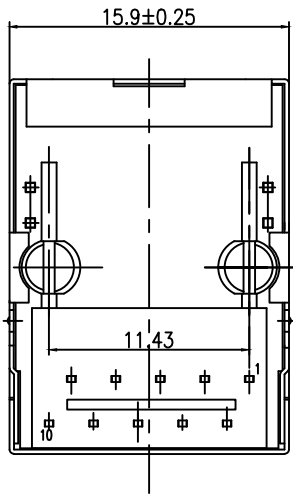

All contacts recessed below top of housing and must be at the same height approximately.

All dimensions follow :
FCC subpart F, 68,500, Figure (C)(2)(i)
IEC 60603-7

STANDARD MODULAR PLUG ASSEMBLY

NOTES : 1. Tolerance : PCB ±0.05mm
Connector ±0.25mm
2. Connector dimensions comply with FCC 68.5 dimension requirements

B-TOP 东莞市博腾电子科技有限公司
Btop Tech Dongguan BtopTech Electronic Technology Co., Ltd.

DIM. TOL.
X ±0.30
X.X ±0.20
X.XX ±0.15
X.XXX ±0.10
GENERAL ANGLE: ±3°

UNIT: mm
SCALE: 1:1
SHEET: 1 of 2
DWG. SIZE: A4
LAYER: XXXX

WEBSITE: WWW.BTOPTECH.COM
WWW.BTOPTECH.CN
TEL: 0769-38928198
FAX: 0769-38928199

DRAWN:
CHECKED:
APPROVED:

TITLE: B50S(28-53)G8-09-P213-B52
PART NO.: TAB-UP21.6 10/100/1000BASE W/ SHELL W/ LED

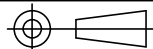

XA	NEW RELEASE	xxxx	Jason	2018-Apr-17
REV.	DESCRIPTION	ECN NO.	NAME	DATE

REVISIONS

Meets or exceeds IEEE 802.3 standard for 10/100/1000 Base-T
 350 uH minimum OCL with 8mA DC bias current
 Available with or without LEDs
 Minimum 1500Vrms isolation per IEEE802.3 requirement
 Operating temperature -0°C to +70°C
 Storage temperature -40°C to +85°C

2. TRANSFORMER ELECTRICAL SPECIFICATIONS AT 25°C;

Insertion Loss (dB max.)	Return Loss (dB min.)				Cross talk (dB min.)			C.M.R. (dB min.)		Hi - pot (Vrms)
	1-30 MHz	30-60 MHz	60-80 MHz	80-100 MHz	1-30 MHz	30-60 MHz	60-100 MHz	10-60 MHz	60-100 MHz	
1-125MHz	-18	-16	-12	-10	-40	-35	-30	-40	-30	60Hz/1min.
-1.2	-18	-16	-12	-10	-40	-35	-30	-40	-30	1500

3. SCHEMATIC:

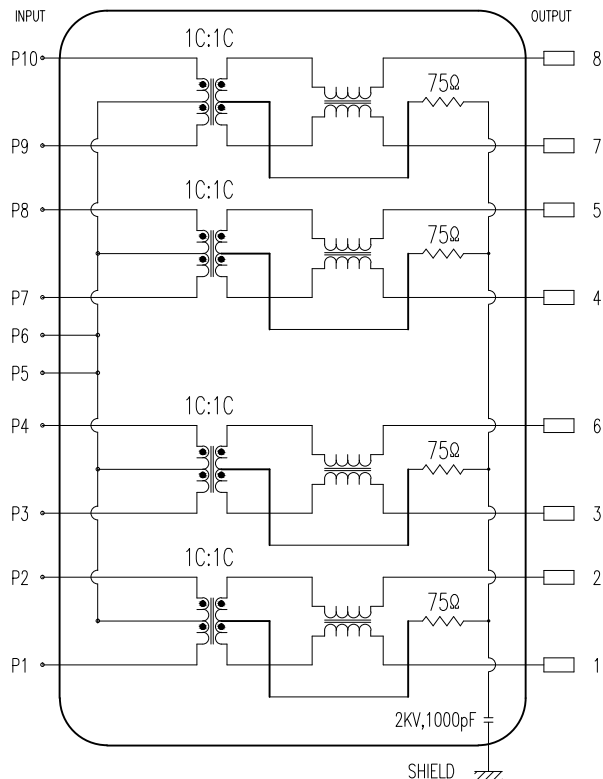

4. Pin Assignment For PCB Layout

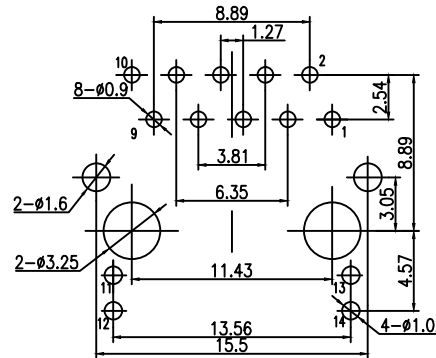

Suggested PCB Pad Layout
Component Side View

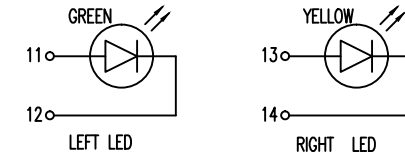

Standard LED Color	LED Wavelength	Forward (V MAX)	Typical (V TYP)	Luminous Intensity
Green	560-580nm	2.5V	2.1-2.2V	9-25MCD
Yellow	580-610nm	2.5V	2.1-2.2V	9-30MCD

LED Specification

5. ORDER INFORMATION

"B" with the company code

Series of products:
 80: Double deck RJ45 connector+transformer series (in sidelong footprint);
 59: Double deck RJ45 connector+transformer series (in vertical footprint);
 50: Single RJ45 + transformer series;
 52/53/55/56 LED/56/57/59: Ordinary RJ45 series; DX: that strip line series;
 40: Conversion said Connectivity
 80: Series that UK;
 91: Automotive connector public Block;
 92: Automotive connector mother Block;
 93: HDMI the head;
 94: HDMI mother Block;
 95: SMT series;
 96: RHS for switches

Family code (sequence id) : -1-99

Type of product code:
 G: Gigabit RJ45 transformer;
 F: 100Base RJ45 transformer;
 W: for no transformer RJ45 products;
 M: Series for board-to-board code

Number of magnetic ring

The No. of circuit

Product definition LOGO:
 1-Press "B-TOP"; 2-No "B-TOP";
 3- Other companies LOGO

Product definition plastic materials:
 1-PA66, 2-PA46, 3-PA, 4-PA6, 5-PBT,
 6-ABS, 7-PA9T, 8-PC, 9-LCP

Pin definition of the product:
 F-Pin after; B-Pin back; C- No
 definition of the product

Electroplating product definition:
 gold-plated terminals (degrees after nickel plated)
 1-Fμ; 2-3μ; 3-6μ; 4-15μ; 5-30μ;
 6-50μ; 7-(Ni-50μ, Sn-80-120μ)

Product shielding definition:
 0-no shielding shell; 1-without shielding shell shrapnel;
 2-shielding a shell shrapnel; 3-a half-shield shell;

Products luminous definition:
 0- No LED; 1-Left Yellow Right Green; 2- Left Green Right
 Yellow; 3- Double Green; 4- Double Yellow; 5- LED straight
 for the pin; 6- A special definition; 7- Single linear LEDs

Products output:
 1-2X1, 2-2X2, 4-2X4, 5-2X5, 6-2X6, 8-2X8, A-1X1,
 B-1X2, C-1X4, D-1X5, E-1X6, T-1X8, U-(USB+RJ45), P-TAB
 UP1X1, H-TAB UP1X2, K-TAB UP1X4;

B-TOP 东莞市博腾电子科技有限公司
 Btop Tech Dongguan BtopTech Electronic Technology Co., Ltd.

TITLE: B50S(28-53)G8-09-P213-B52
 PART NO.: TAB-UP21.6 10/100/1000BASE W/ SHELL W/ LED

DIM. X X.X X.XX X.XXX
 TOL. ±0.30 ±0.20 ±0.15 ±0.10
 GENERAL ANGLE: ±3°

UNIT: mm
 SCALE: 1:1
 SHEET: 2 of 2
 DWG. SIZE: A4
 LAYER: XXXX

WEBSITE: WWW.BTOPTECH.COM
 WWW.BTOPTECH.CN
 TEL: 0789-38928198
 FAX: 0789-38928199
 DRAWN:
 CHECKED:
 APPROVED:

REV.	DESCRIPTION	ECN NO.	NAME	DATE
XA	NEW RELEASE	XXXX	Jason	2018-Apr-19

REVISIONS