

1

2

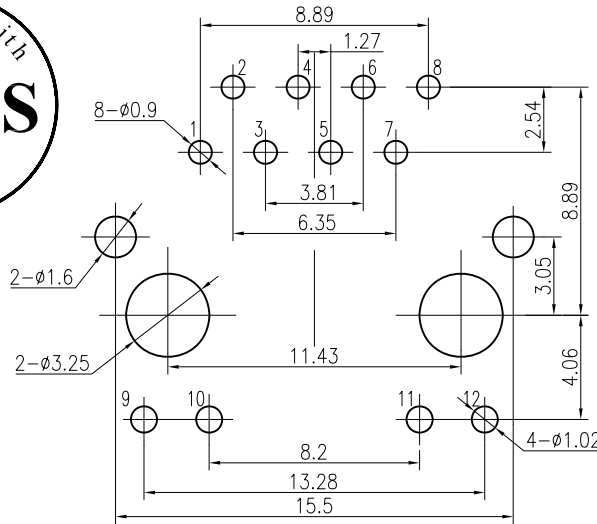

PCB BOARD LAYOUT

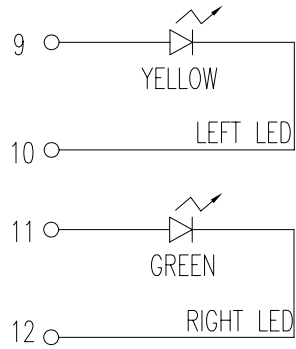
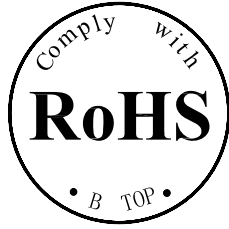
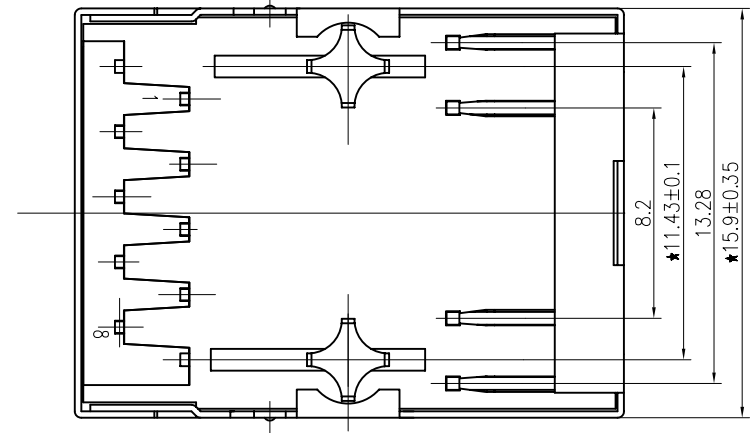

LED Specification

Standard LED Color	LED Wavelength	Forward (V MAX)	Typical (V TYP)	Luminous Intensity
Green	560-580 nm	2.5V	2.1-2.2V	9-25 MCD
Yellow	580-610 nm	2.5V	2.1-2.2V	9-30 MCD
Orange	580-610 nm	2.5V	2.1-2.2V	50-100 MCD

- LED intensity/wavelength measured with Photo Research PR-650 Colormeter
- With a forward current of 20 mA, Absolute Maximum Ratings (Ta=25°C)

- 1: TOLERANCES UNLESS OTHERWISE SPECIFIED :
 0~10±0.15, 10~20±0.2, 20~40±0.25,
 40~70±0.3, ≥70±0.4
- 2: JACK CAVITY CONFORMS TO FCC RULES AND REGULATIONS, PART 68 SUBPART F.

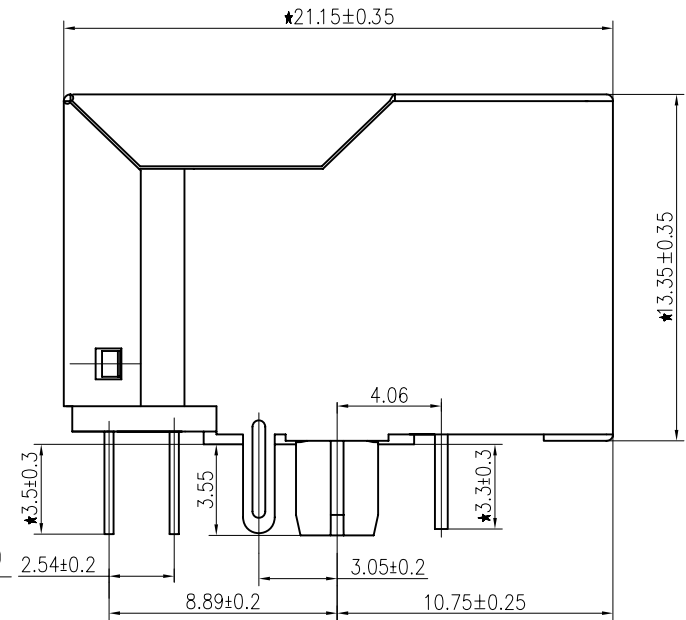
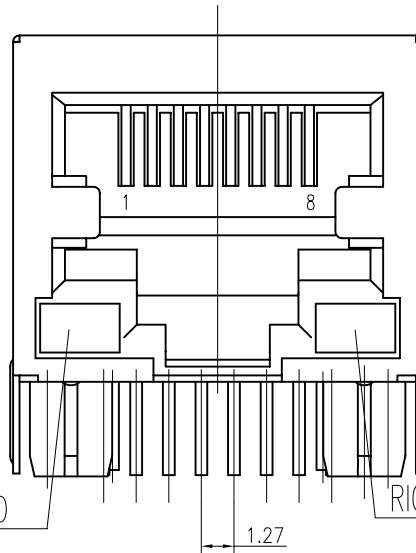

B-TOP® 东莞市博腾电子科技有限公司
 Dongguan BroadTop Electronic Technology Co., Ltd.

Designed
 Checked
 Approved

MATERIAL
 SCALE 3.5:1 UNIT mm

DESCRIPTION B50(27-130)F4-42A-A113-B52(1X1 Y-G 4.06 LED)
 MODEL NO.
 REV. V1.1

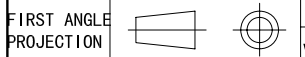

20170801

1

2

DESCRIPTION

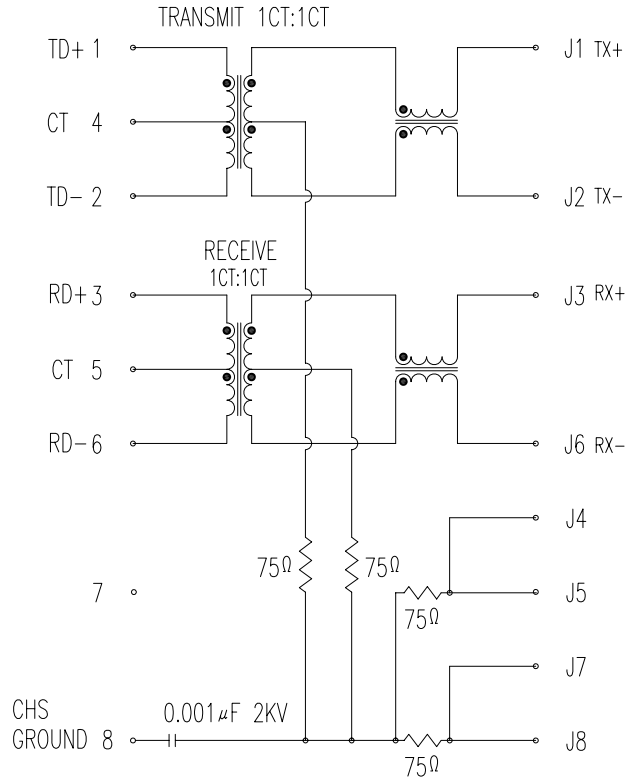

ELECTRICAL: RJ45 With internal Magnetics Connector
 Designde to support such applications as:Ethernet Equipment Complex,Switches,Routers,Firewalls,Servers and Hub
 Internal magnetics are 100% electrically tested for functionality per IEEE802.3 requirement
 RoHS peak wave solder temperature rating 235℃
 High performance for maximum EMI suppression
 350uH minmum OCL with 8mA bias current

MECHANICAL: JACK CAVITY CONFORMS TO FCC RULES AND REGULATIONS,PART 68 SUBPART F.
 INSERTION FORCE: 8 CONTACTS--900g,10 CONTACTS--1050g
 RETENTION STRENGTH: 7.7Kgs BETWEEN JACK AND PLUG
 DURABILITY: 750 MATING CYCLES Mini

MATERIAL: HOUSING: 1) GLASS FILLED PA66 (UL 94V-0)
 2) GLASS FILLED PA46/PA6T/PA9T/LCP<265℃> (UL 94V-0)
 3) GLASS FILLED PBT/PA/ABS/PC (UL 94V-0)

SPRING WIRE: 0.25-0.35mm THICKNESS PHOSPHOR BRONZE ALLOY SELECTIVE GOLD PLATING OVER NICKEL<50-80μ">
 OVER TIN<60-120μ">

GOLD PLATING: 3μ", 6μ", 15μ", 30μ", 50μ"

SHIELDING: 0.2-0.24mm THICKNESS COPPER ALLOY WITH NICKEL<50-100μ"> PLATED

Storage: -40℃~85℃ Relative Humidity<70%

Operating: 0℃~70℃

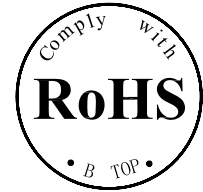

ELECTRICAL SPECIFICATIONS AT 25°C

Insertion Loss dB max	Return Loss dB min		Crosstalk(dB TYP)	Common Mode Rejection (dB TYP)	Hipot(vrms)
1-125MHz	1-30MHz	30- 80MHz	1- 100MHz	1-100MHz	
-1.2	-18	-18+20log(f/30MHz)	-30	-30	1500/0.5mA OR 2250DC/0.1mA

"B" with the company code

Series of products: 60:Double deck RJ45 connector + transformer series(In sidelong footprint); 39:Double deck RJ45 connector + transformer series(In vertical footprint);50: Single RJ45 + transformer series;52/53/55/56 LED/56/57/59: Ordinary RJ45 series;DX: that strip line series; 40: Conversion said Connectivity 80: Series that UK; 91: Automotive connector public Block;92: Automotive connector mother Block; 93: HDMI the head;94: HDMI mother Block; 95: SMT series; 96: RBIS for switches

Family code (sequence id) :1-99

Type of product code: G: Gigabit RJ45 transformer; F: 100Base RJ45 transformer; W:for no transformer RJ45 products; M: Series for board-to-board code

Number of magnetic ring

The No. of circuit

Product definition LOGO: 1 - Press "B-TOP";2- No "B-TOP"; 3- Other companies LOGO

Product definition plastic materials: 1-PA66,2-PA46, 3-PA, 4-PA6, 5-PBT, 6-ABS, 7-PA9T,8-PC,9-LCP

Pin definition of the product:F-Pin after; B-Pin back; C- No definition of the product

Electroplating product definition: gold-plated terminals(degrees after nickel plated) 1-F μ " ; 2-3 μ " ; 3-6 μ " ; 4-15 μ " ; 5-30 μ " ; 6-50 μ " ; 7-150 μ " ; Sn-80-120 μ ");

Product shielding definition: 0 - no shielding shell; 1 - without shielding shell shrapnet; 2 - shielding a shell shrapnet; 3 - a half-shield shell;

Products luminous definition: 0 - No LED; 1 - Left Yellow Right Green; 2 - Left Green Right Yellow; 3 - Double Green; 4 - Double Yellow; 5 - LED straight for the pin; 6 - A special definition;7 - Single linear LEDs

Products out port: " 1-2X1" 2-2X2" 4-2X4" 5-2X5" 6-2X6" 8-2X8" A-1X1" B-1X2" C-1X4" D-1X5 " E-1X6" T-1X8" U-(USB+RJ45)" P-TAB UP1X1" H-TAB UP1X2" K-TAB UP1X4"

B N (Z) G X - M - A B C D - E H I

B-TOP® 东莞市博腾电子科技有限公司
 Dongguan BroadTop Electronic Technology Co., Ltd.

Designed 吴礼刚

Checked

Approved Yonghong Zhu

MATERIAL

DESCRIPTION

BT F4-42A

FIRST ANGLE PROJECTION

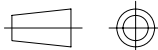

TEL: 0769-38926198
 FAX: 0769-38926199
 Website: www.BtopTech.com

SCALE

1.8:1

UNIT

mm

MODEL NO.

B800100042A11

REV.